

Date _____

Name _____

Client _____

Project name _____

Quote# _____

Type/Quantity _____

LASS-OH! 60160 92734
24813 9220

[Weblink](#)

AVAILABLE AS FROM 05/2019 (CONTACT US FOR MORE DETAILS)

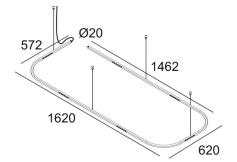
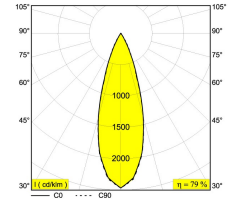

Available colors: BLACK (24813 9220 B)
 GOLD COLORED ANODIZED (24813 9220 GC)

INCL.6 x DOT.COM S6 modules
 PER MODULE: 6 x LED 1W / CRI>90 / 2700K / 98lm
 PER MODULE: 6 x REFLECTOR FL-34°
 EXCL.LED POWER SUPPLY 1050mA-DC
 INCL.4 x CABLE SUSPENSION SINGLE AUTO. 1,6m
 INCL.1 x CABLE 2 x 0.75mm²
 Other CRI or KELVIN on request

LED Technics: Light source: 3528 lm // 36 W // 98 lm/W
 Luminaire: 2788 lm // 42 W // 67 lm/W

Class: III

Weight: 1.9 KG

Protection level: IP20

Minimum distance: n.a.

Options: CABLE BASE R / S
 COVERSET R 62-90-100 / S 62-80-90



Accessories: JIHA S / R

Requirements: LASS-OH! POWERBOX
 LED POWER SUPPLY 1050mA-DC DIM

For detailed installation instructions, please consult the manual.

LASS-OH! 60160 92734
24813 9220

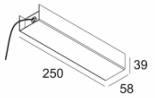
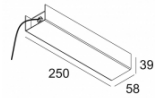
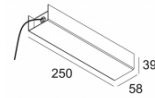
Related references
LED POWER SUPPLIES

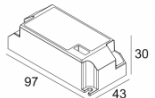
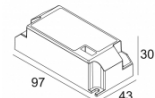
<p>Weblink / Specsheet</p>  <p>LASS-OH! POWERBOX 24814 0010 220-240V / 50-60Hz Number of luminaires: 1</p>	<p>Weblink / Specsheet</p>  <p>LASS-OH! POWERBOX DIM1 24814 0011 220-240V / 50-60Hz Number of luminaires: 1</p>	<p>Weblink / Specsheet</p>  <p>LASS-OH! POWERBOX DIM5 24814 0015 220-240V / 50-60Hz Number of luminaires: 1</p>	<p>Weblink / Specsheet</p>  <p>LED POWER SUPPLY MULTI POWER 21012 0010 220-240V / 0/50-60Hz Number of luminaires: 1</p>
<p>Weblink / Specsheet</p>  <p>LED POWER SUPPLY MULTI POWER DIM1 21012 0021 220-240V / 0/50-60Hz Number of luminaires: 1</p>	<p>Weblink / Specsheet</p>  <p>LED POWER SUPPLY MULTI POWER DIM5 21012 0035 220-240V / 0/50-60Hz Number of luminaires: 1</p>		

Related references
COVERSETS

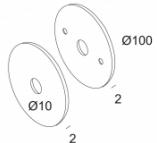
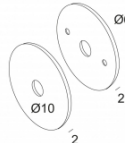
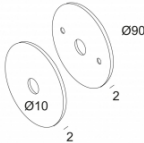
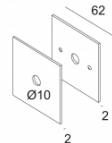
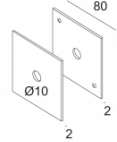
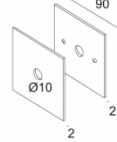
<p>Weblink / Specsheet</p>  <p>COVERSET R 100 204 00 100</p>	<p>Weblink / Specsheet</p>  <p>COVERSET R 62 204 00 62</p>	<p>Weblink / Specsheet</p>  <p>COVERSET R 90 204 00 90</p>	<p>Weblink / Specsheet</p>  <p>COVERSET S 62 204 62 62</p>
<p>Weblink / Specsheet</p>  <p>COVERSET S 80 204 80 80</p>	<p>Weblink / Specsheet</p>  <p>COVERSET S 90 204 90 90</p>		

Related references
SUSPENSION PARTS

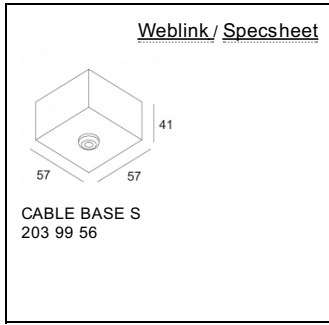
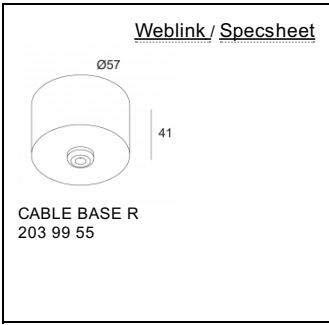

Related references

LIGHT ALTERING DEVICES

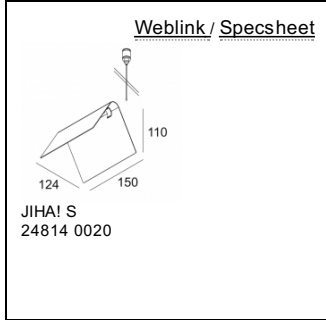
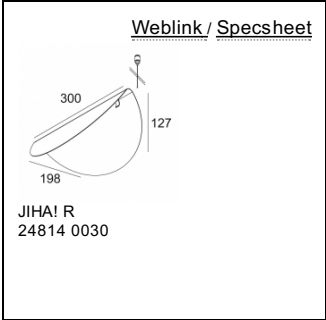

Specification Sheet

LASS-OH! 60160 92734
24813 9220

Related project picture of product family:

