

29,50 Kg
Weight without
basket

80L
Capacity

1.020 mm
Height

420 mm
Maximum diameter

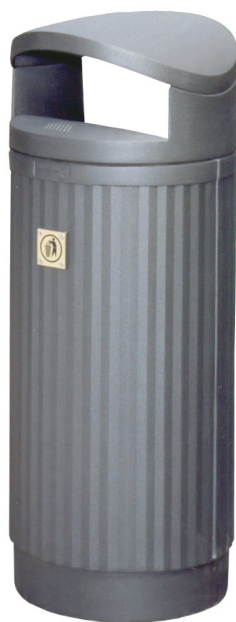

FEATURES

Body, top, base and upper reinforcing rim made of cast sand-blasted aluminium, painted ronoxide grey. All metal parts are made of stainless steel or cast aluminium to prevent corrosion.

They are designed with vertical fluting that reinforces the whole assembly providing originality and elegance. This fluting makes it difficult to stick posters and labels to the body of the bin.

The filling area consists of a fixed top cover joined vertically by two side panels to a lower ring, integral with the body, forming two openings, accessible at 180°, for depositing litter.

The circular 80 litre body into which the litter is deposited houses the door for emptying. A locking system with a standard triangular key is provided to prevent unauthorized access.

Can be customised by means of a badge affixed to the body, maximum size 120 x 120 mm.

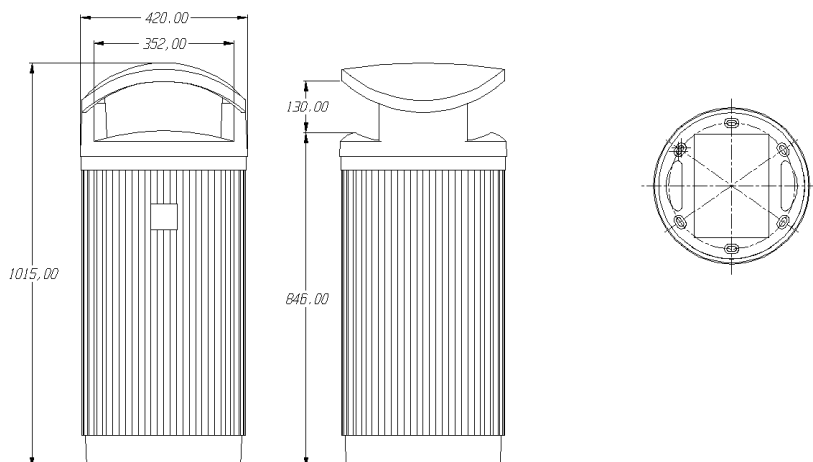

ATTRIBUTES



QUALITY



ERGONOMIC



DESIGN

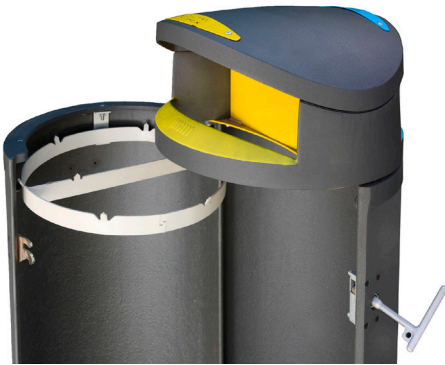

EQUIPMENT

Integral cigarette stubber; ashtray can be supplied on request.
65 l basket has a reinforced ring in the upper part and is fitted with an integral handle to make emptying easier for maintenance staff.

There is the option of replacing the basket with a refuse sack. The system can also be used to segregate two separate materials if a two-compartment basket is fitted.

Anti-vandal support base is integrated into the body and is fixed to the pavement simply and securely by means of six 12mm universal expansion bolts.

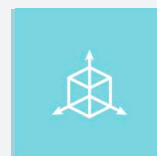

Design



Customised



Easy to clean

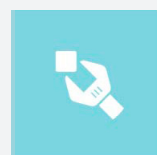

Easier maintenance

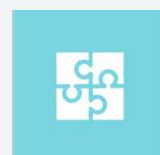

Easier assembled

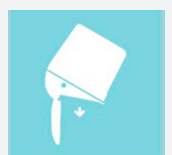

Easier emptying