

40_L
Capacity

343_{mm}
Depth

487_{mm}
Height



FEATURES

Body and lid manufactured from virgin polypropylene for protection against atmospheric conditions.

Metal handle manufactured from galvanized steel.

Fixed dimensions, absorbs everyday impacts without denting or cracking.

Selective household collection is made easy by a compartment system enabling it to be segregated into two or three separate sections.

Available in a wide range of colours.

Customisation of the body with thermal transfer graphic - maximum area 200 x 200 mm and with embossed logo - maximum area 340 x 250 mm.

Customisation of lid with an embossed logo - maximum area 160 x 230 mm.

STANDARDS

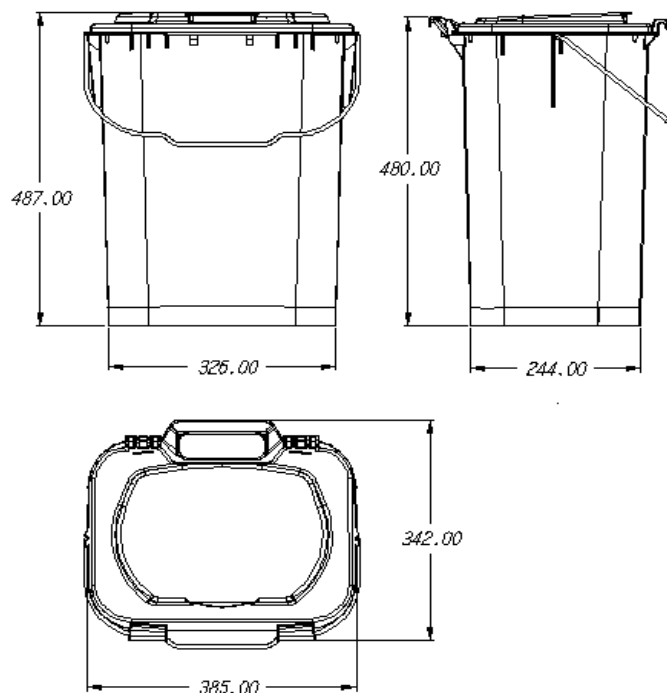

ATTRIBUTES



VERSATILITY



ERGONOMICS

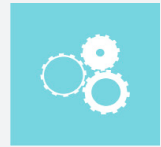

FUNCTIONALITY



CUSTOMISATION



AVAILABLE IN A WIDE RANGE OF COLOURS

EQUIPMENT

The bin has an integrated handle for easier manoeuvrability.

Ergonomic insets at the base of the bin make emptying easier.

Clip system to prevent the metal handle from dropping.

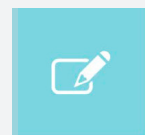

Customisation

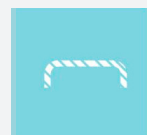

Metallic handle

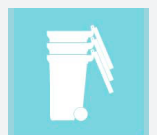

Easy to stack

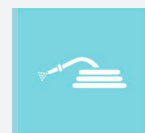

Easy to clean

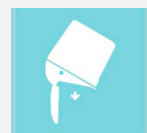

Easier emptying

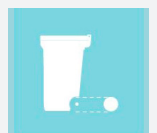

Easy to install