

1.100_L
Capacity

440_{Kg}
Nominal load

200 mm
Wheels diameter



FEATURES

The body and lid are injection moulded in solid coloured high-density polyethylene.

Manufactured using environmentally-friendly recyclable materials.

No heavy metals in the pigments.

Ideal for different types of waste collection: paper and cardboard, glass, packaging, organic matter, etc. ...

Available in a wide range of colours..

DIN lifting systems.

Customisation of lid with thermal transfer graphic, area: 230 x 45 mm.

Customisation of body with silk screen or thermal transfer graphic, area: 300 x 400 mm.

CE Marking with sound power level indicated in accordance with European Directive 2000/14/EC. 85,4 db.

Product Approval Certificate awarded by TÜV Product Service GmbH in accordance with European Standard EN 840:2012 .

The C1100 TC HD container complies with the RAL GZ 951/1 specification.

STANDARDS

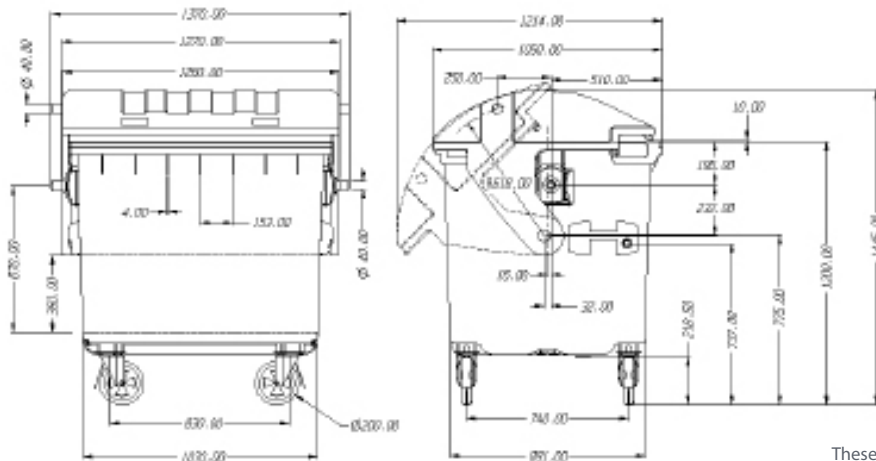

These dimensions are subject to the tolerances given in EN 840-1:2012.

ATTRIBUTES



QUALITY



ACCESIBILITY

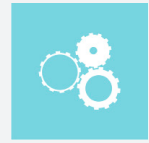

FUNCTIONALITY

ACCESSORIES



GLASS APERTURE



PLASTIC APERTURE

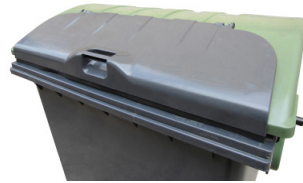

RAIN COVER



CENTRAL BRAKE SYSTEM

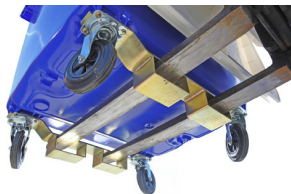

LIFTING SYSTEM



SECURITY SYSTEM



PEDAL



AVAILABLE IN A WIDE RANGE OF COLOURS

EQUIPMENT

200 mm diameter wheels.

Openings with sizes and features specially designed to accommodate each type of waste, making them easy to use.

Security system in the lid.

Integrated handles in the body and lid for easy handling.

Recess for electronic chips.

Can be equipped with a range of accessories providing real solutions to every requirement: pedal-operated lid opening, reflective strips, lock, side handle.

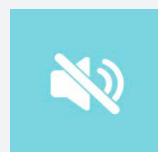

Sound-proofing

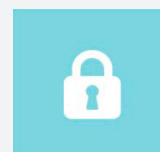

Lock



Easy to stack

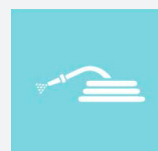

Easy to clean



Brake

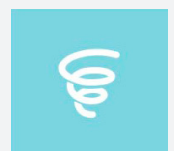

Shock absorber