

240_L
Capacity

96_{Kg}
Nominal load

200/250_{mm}
Wheels diameter



FEATURES

Manufactured using injection moulded solid-coloured high-density polythene, stabilised against the combined effects of water and UV radiation.

It is manufactured using environmentally-friendly, recyclable materials.

No heavy metals in the pigments used.

Customised containers for each type of waste collection: paper and cardboard, glass, plastics, organic...

DIN lifting system.

Customisation of body with silk screen or thermal transfer graphic, area: 260 x 250 mm.

Customisation of lid with thermal transfer graphic area: 230 x 45 mm.

CE marking with sound power level indicated in accordance with European Directive 2000/14/CE. 77db.

Product approval certificate awarded by TÜV Product Service GmbH in accordance with European Standard EN 840.

STANDARDS

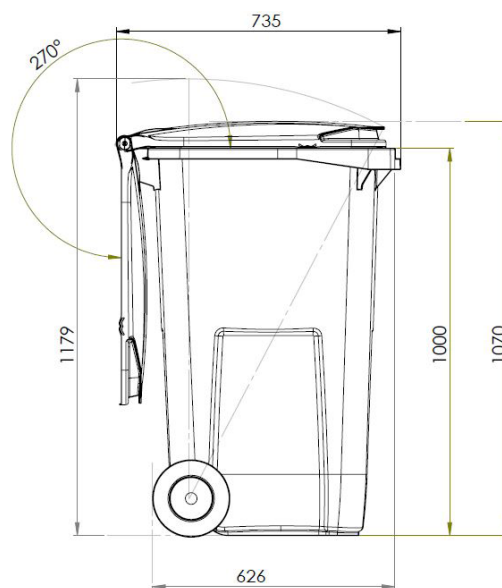
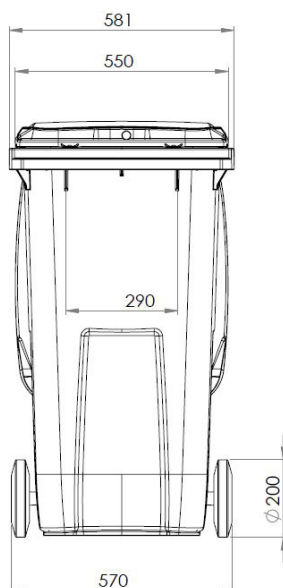

Note: These dimensions are subject to the tolerances given in EN-840-1:2013

PRODUCT ATTRIBUTES



QUALITY



ERGONOMIC

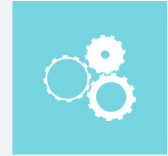

FUNCTIONALITY

CUSTOMIZATION



GLASS OPENING



PLASTIC OPENING



PAPER OPENING



SIDE HANDLE



CUSTOMISATION



NUMBERING



PEDAL



WIDE RANGE OF COLOURS

DESCRIPTION

Openings with sizes and features specially designed to accommodate each type of waste, making them easy to use.

Integrated sound-proofing system in the lid.

Recess for the installation of electronic chips.

Can be equipped with a range of accessories providing real solutions to every requirement: pedal-operated lid opening, reflective strips, lock, side handle.

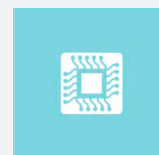

Electronic chip

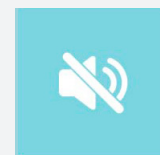

Insonorisation

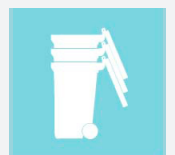

Easy to stack



Lock



Numbering

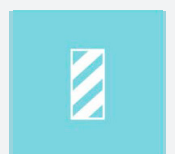

Reflective strips