

**120<sub>L</sub>**  
Capacity

**48<sub>Kg</sub>**  
Nominal load

**200<sub>mm</sub>**  
Wheels diameter



### FEATURES

Manufactured using injection moulded solid-coloured high-density polythene, stabilised against the combined effects of water and UV radiation.

It is manufactured using environmentally-friendly, recyclable materials.

No heavy metals in the pigments used.

Customised containers for each type of waste collection: paper and cardboard, glass, plastics, organic...

DIN lifting system.

Customisation of body with silk screen or thermal transfer graphic, area: 260 x 250 mm.

Customisation of lid with thermal transfer graphic, area: 230 x 45 mm.

CE marking with sound power level indicated in accordance with European Directive 2000/14/CE. 79db.

Product approval certificate awarded by TÜV Product Service GmbH in accordance with European Standard EN 840.

### STANDARDS

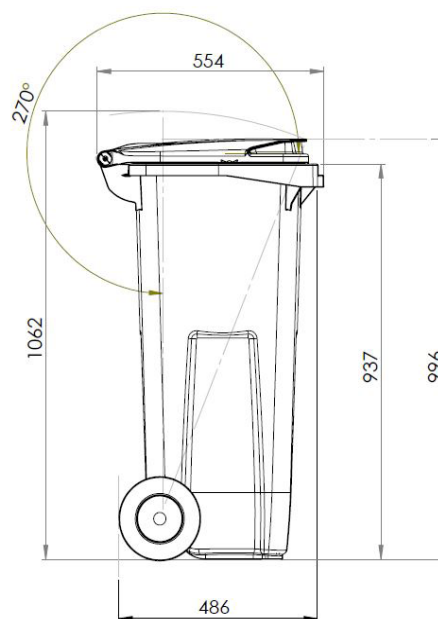
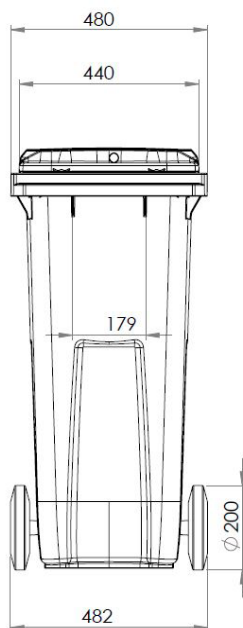

Note: These dimensions are subject to the tolerances given in EN-840-1:2013

## PRODUCT ATTRIBUTES



QUALITY



ERGONOMIC

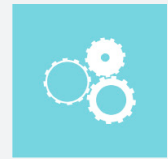

FUNCTIONALITY

## CUSTOMIZATION



GLASS OPENING



PLASTIC OPENING



PAPER OPENING



SIDE HANDLE



CUSTOMISATION



NUMBERING



PEDAL



WIDE RANGE OF COLOURS

## DESCRIPTION

Openings with sizes and features specially designed to accommodate each type of waste, making them easy to use.

Integrated sound-proofing system in the lid.

Recess for the installation of electronic chips.

Can be equipped with a range of accessories providing real solutions to every requirement: pedal-operated lid opening, reflective strips, lock, side handle.

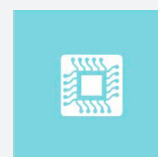

Electronic chip

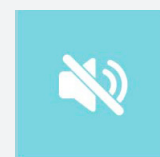

Insonorisation

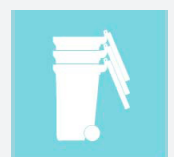

Easy to stack

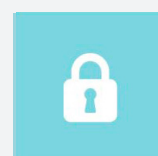

Lock



Numbering

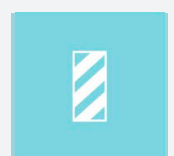

Reflective strips