

PRODUCT CATALOGUE



CONTENÜR



CONTENUR

Torneros 3
Pol. In. Los Ángeles
28906 Getafe
Madrid, Spain

www.contenur.com/en

PRODUCT
CATALOGUE

INDEX

06

THE COMPANY

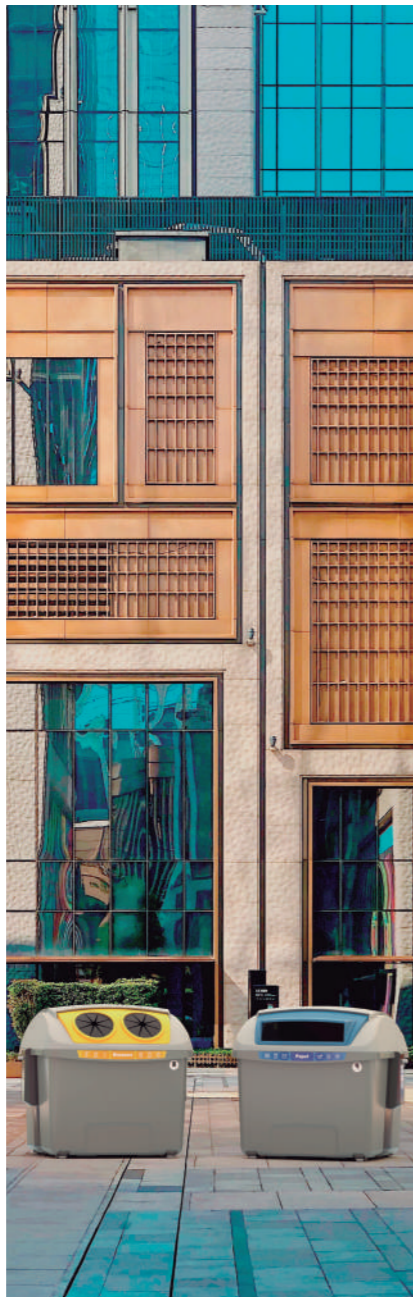

12

CONTAINERS

REAR-LOADING
SIDE-LOADING
CRANE-LIFT RANGE



82

UNDERGROUND
CONTAINERS

CRANE-LIFT RANGE
REAR-LOADING
SIDE-LOADING
DISPOSAL COLUMNS



104

LITTER BINS

OMEGA
AGORA
EUROPA
MILENIUM
DIN
BARCELONA
GOYA
CLASSIC



136

SUSTAINABILITY

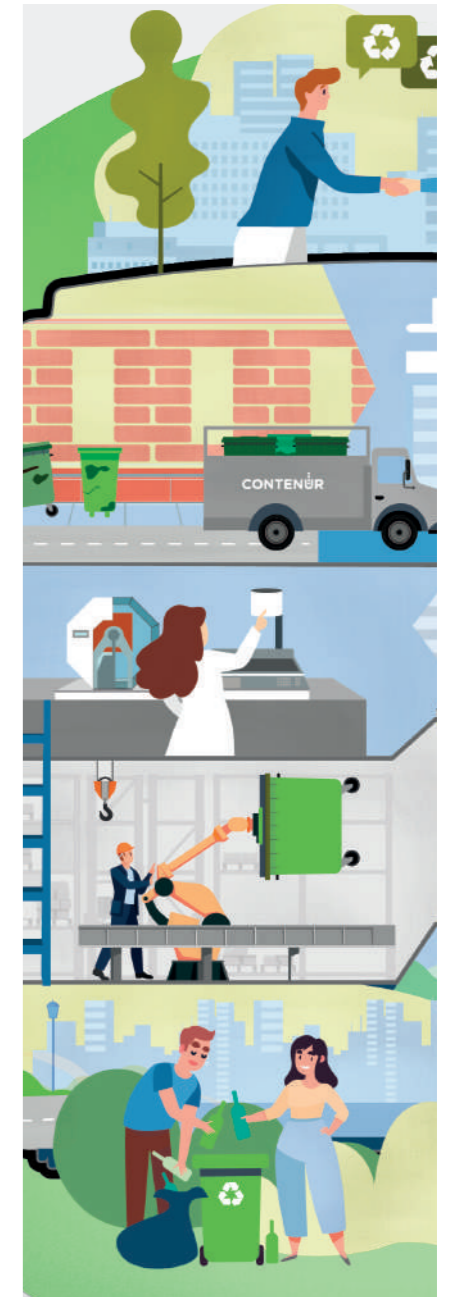

THE COMPANY

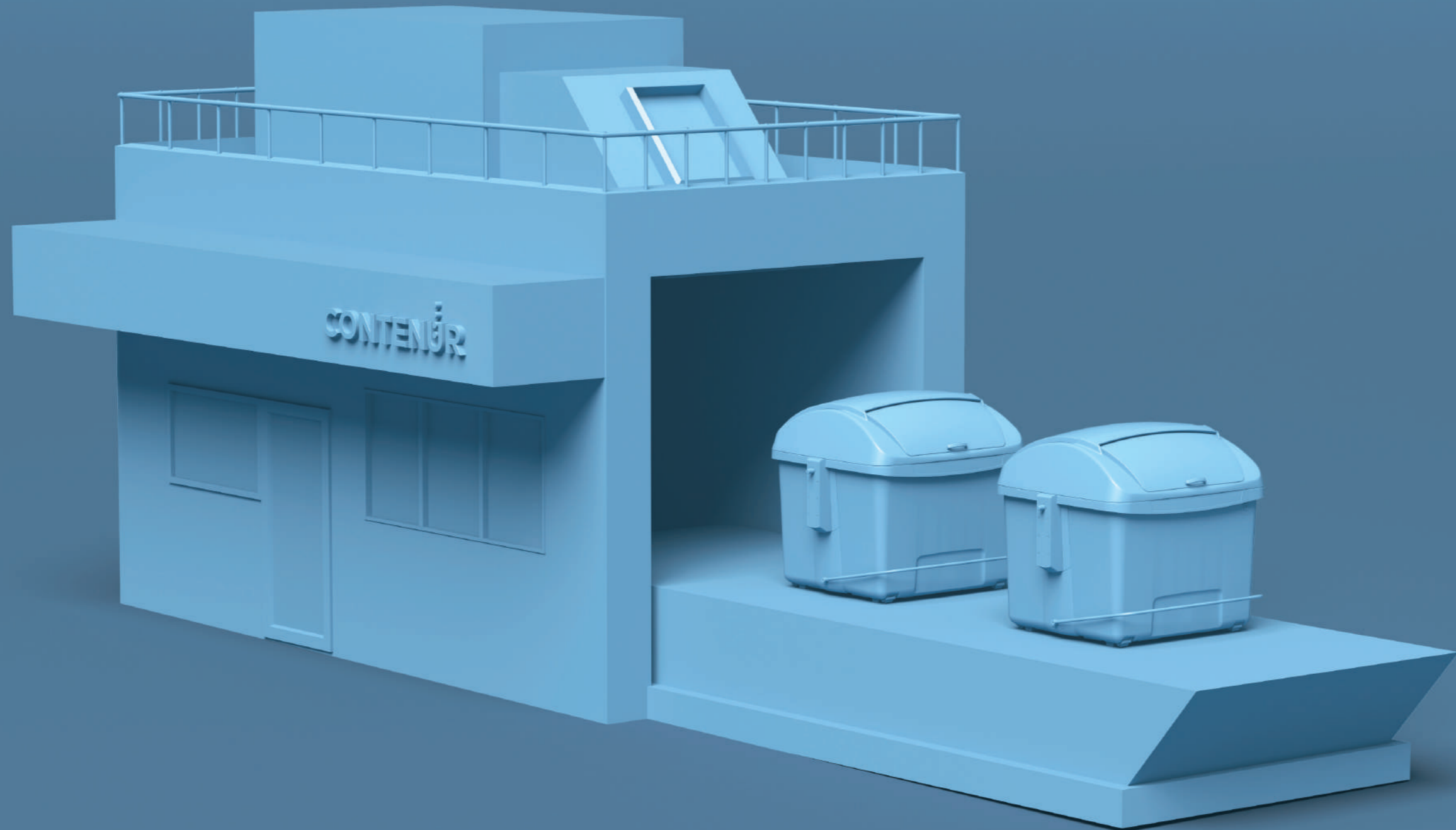

CLICK ON CERTAIN ITEMS
TO LEARN MORE.



THE COMPANY

Providing solutions for more than 35 years

CONTENUR is involved in designing, manufacturing, marketing and maintaining urban waste containers, to improve the quality of life, sustainability and city landscaping.

Our industrial activity is completed with a wide range of services, which include advice on adequate product implementation and the comprehensive maintenance of container parks, comprehensive management of litter bins and dog excrement bins, leisure areas, sports facilities and children's parks, in those cities where we are present.

It has been more than 35 years since **CONTENUR** played a leading role in containerisation as a phenomenon in Spain, becoming a reference company in the municipal solid waste sector when it opened its production plant in Getafe (Madrid).

Since its incorporation in 1984, **CONTENUR** has always pursued products and services conceived to improve urban waste management, taking on a fundamental role in Europe's containerisation process.

A COMPANY THAT IS PRESENT WORLDWIDE TO PROVIDE LATEST GENERATION SOLUTIONS ►

Today, further to its experience as a leader on the Iberian market and the third most important in Europe, striving to consolidate its international growth and operations in more than 50 countries all over the world, **CONTENUR** offers city-tailored solutions that are flexible, integrated into their surroundings and day-to-day life.

One of **CONTENUR's** cornerstones is its international growth. This is why, in the 90's, it embarked on a new stage for growth by opening subsidiaries in Portugal, Italy, France and the United Kingdom; in 2011 it opened up branch offices in Poland and Morocco; and in 2013 in Brazil, Colombia and Germany, thereby helping further the containerisation process elsewhere.

Since then, **CONTENUR** has continued to consolidate its international expansion by achieving milestones, such as the inauguration of a production centre in Poland in 2012; the purchase of its third productive plant in Mandirituba (Brazil); opening up its subsidiaries in Singapore and the Czech Republic, in 2016 and 2017 respectively; and inaugurating its fourth industrial plant in the United Kingdom in 2021.



WASTE CONTAINERISATION SOLUTIONS ▶



CONTAINERISATION AND CONSULTANCY SERVICES

We offer advice and consultancy services to ensure that the best mechanised collection system is implemented in each city.



COMPREHENSIVE QUALITY SERVICE

CONTENUR programmes the best service for each city area and urban surroundings, optimising costs and maximising quality. It presents its clients with highly qualified staff, offering extensive experience, in order to cover inspection, maintenance and repair tasks related to containers and urban fixtures.



MANUFACTURING AND INSTALLATION

CONTENUR has the latest production resources and technology available in the sector.



DATA MANAGEMENT

Seeking to offer a comprehensive quality service, **CONTENUR** provides a data management service enabling service tracing through Smart solutions.

WHY CHOOSE CONTENUR? ▶



CONTENUR's EXPERIENCE in containerisation systems and associated services, guarantees innovating solutions that are both solid and reliable. This has constituted the company's hallmark for more than 35 years.



Environmental friendliness and our **COMMITMENT TO SUSTAINABLE DEVELOPMENT** evidence **CONTENUR's** contribution in environmental issues, establishing different standardised environmental management systems in all its activities.



An **INTERNATIONAL OUTLOOK** and long-term vision have made **CONTENUR** the best option for our clients in over 50 countries.



INNOVATION is the key when developing new ways in which to respond to our clients' needs.



QUALITY, service level, proximity and a personalized service, along with client commitment have positioned the **CONTENUR** brand as a reference in developing solutions for cities.



A **TEAM** of trained professionals, committed to the company's values, have turned **CONTENUR** into its clients' favourite choice and a source of motivation for its employees.



Product **DESIGN** with solutions conceived for integration into urban surroundings, as another component, to encourage recycling and environmental friendliness.



CONTAINERS

▶ REAR-LOADING

▶ SIDE-LOADING

▶ CRANE-LIFT RANGE



CLICK ON CERTAIN ITEMS
TO LEARN MORE.



REAR-LOADING CONTAINERS

The fullest range

CONTENUR's Rear-Loading containers are designed with all aspects of ergonomics and aesthetics. Manufactured with high-density injected polyethylene and designed to facilitate their use, efficiency and durability.

Designed to facilitate stacking and optimise logistics, thus helping reduce CO² emissions during transportation.

Manufactured under the highest international quality standards in each field of activity (DIN, EN-840, ISO, UN), these containers are the most resistant the market has to offer.

Available in a wide range of colours, they offer a complete series of accessories in order to cover any issue that may arise in each city's waste collection.

Thanks to their small number of manufacturing parts, they are easily assembled and installed without difficulty.

Different versions exist for each type of collection: paper and cardboard, glass, packaging, organic and other waste, etc.



QUALITY



ERGONOMICS



WIDE RANGE



CLICK ON CERTAIN ITEMS
TO LEARN MORE.



2-WHEELS

REAR-LOADING CONTAINERS ▶

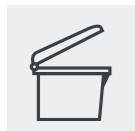

LID OPENING

Designed to lower slowly, ensuring a smooth shifting of the lid and noiseless closing.

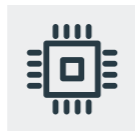

RFID CHIPS

Space inside the container body for chip hosting. This facilitates container identification and tracking.



SOUNDPROOFING

Our design includes an exclusive leaf-spring soundproofing system to reduce the noise print.



WHEELS

Wheels designed to avoid adhered dirt and to facilitate cleaning. Fast and simple assembly/dismantling.



HANDLES

Equipped ex works with two handles integrated into the body to facilitate container handling.



CUSTOMISATION

The container body may be customised with emblems, logos, etc., using thermal printing.

Model	Capacity	Nominal load	Wheels diameter
C80	80 L	32 Kg	200 mm
C90	90 L	36 Kg	200 mm
C120	120 L	48 Kg	200 mm
C140	140 L	56 Kg	200/250 mm
C180	180 L	72 Kg	200/250 mm
C240	240 L	96 Kg	200/250 mm
C360	340 L	136 Kg	200/300 mm

C80



- 80 L capacity
- 32 Kg nominal load
- 2 wheels 200 mm

C90



- 90 L capacity
- 36 Kg nominal load
- 2 wheels 200 mm

C120



- 120 L capacity
- 48 Kg nominal load
- 2 wheels 200 mm

C140



- 140 L capacity
- 56 Kg nominal load
- 2 wheels 200/250 mm

C180



- 180 L capacity
- 72 Kg nominal load
- 2 wheels 200/250 mm

C240



- 240 L capacity
- 96 Kg nominal load
- 2 wheels 200/250 mm

C360



- 340 L capacity
- 136 Kg nominal load
- 2 wheels 200/300 mm

CLICK ON CERTAIN ITEMS
TO LEARN MORE.



2-WHEELS

REAR-LOADING CONTAINERS ▶



ACCESSORIES ▶

SELECTIVE OPENINGS –

** Check each model's availability*

Openings used to recycle different types of waste: paper and cardboard, glass, packaging, organic, MSW...

Circular openings, available in the following diameters:

- ▶ Ø150 mm
- ▶ Ø200 mm
- ▶ Ø250 mm
- ▶ Ø300 mm

Paper opening, sizes available:

- ▶ 277 x 65 mm
- ▶ 341 x 80 mm
- ▶ 370 x 85 mm

Brush opening, sizes available:

- ▶ 300 x 30 mm
- ▶ 330 x 150 mm

Opening for confidential waste, size available:

- ▶ 300 x 30 mm
- ▶ 330 x 30 mm

MANUAL OR AUTOMATIC LOCK –

This prevents the container from opening

NUMBERING –

On a plate or thermally printed on the body

CUSTOMISATION –

Thermally printed on the body, maximum size 260 x 260 mm
*except for models 90 and 360 (maximum size 290 x 280 mm).

Thermally printed lid, maximum size 230 x 45 mm

Customisation with a sticker or adhesive vinyl. Both the body and lid of the container may be customised

SIDE HANDLE –

Facilitates container handling



PEDAL –

The pedal accessory is installed in the body to facilitate opening of the lid



LID-IN-LID –

An accessory designed to preserve the selective collection of atmospheric agents and to avoid unpleasant smells. Useful size: 300 x 250 mm

Lid-in-lid options:

- ▶ Unlocked lid-in-lid
- ▶ Manually locked lid-in-lid
- ▶ Electronically locked lid-in-lid



DOUBLE LID SYSTEM –

** Accessory available for models C180 and C240*

The double lid system makes it easy for users to deposit waste when the container is in a hard-to-reach place. The lid's double opening at the back and front makes the container more ergonomic and easier to handle. The system includes a manual lock integrated in the lid and made from high-density polythene



DIVIDED WALL –

** Accessory available for models C180 and C240*

The separator system makes it easier for users to separate waste at source. The accessory divides the inside of the container in two and makes it easier to selectively collect more than one type of waste

CLICK ON CERTAIN ITEMS
TO LEARN MORE.



4-WHEELS

REAR-LOADING CONTAINERS ▶



LID OPENING

Designed to lower slowly, ensuring a smooth shifting of the lid and noiseless closing.

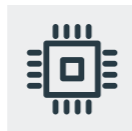

RFID CHIPS

Space inside the container body for chip hosting. This facilitates container identification and tracking.



SOUNDPROOFING

Our design includes an exclusive leaf-spring soundproofing system to reduce the noise print.



WHEELS

All four-wheel containers are fitted ex works with four wheels, 200 mm wide.



HANDLES

Equipped ex works with two handles integrated into the body to facilitate container handling.



CUSTOMISATION

The container body may be customised with emblems, logos, etc., using thermal printing.

Model	Capacity	Nominal load	Wheels diameter
C700	660 L	264 Kg	160/200 mm
C800	770 L	308 Kg	160/200 mm
C1000	1000 L	400 Kg	200 mm
C1100	1100 L	440 Kg	200 mm
C1100 Roll top	1100 L	440 Kg	200 mm

C700



- 660 L capacity
- 264 Kg nominal load
- 4 wheels
160/200 mm

C800



- 770 L capacity
- 308 Kg nominal load
- 4 wheels
160/200 mm

C1000



- 1000 L capacity
- 400 Kg nominal load
- 4 wheels 200 mm

C1100



- 1100 L capacity
- 440 Kg nominal load
- 4 wheels 200 mm

C1100 RT



- 1100 L capacity
- 440 Kg nominal load
- 4 wheels 200 mm

CLICK ON CERTAIN ITEMS
TO LEARN MORE.



4-WHEELS

REAR-LOADING CONTAINERS ▶

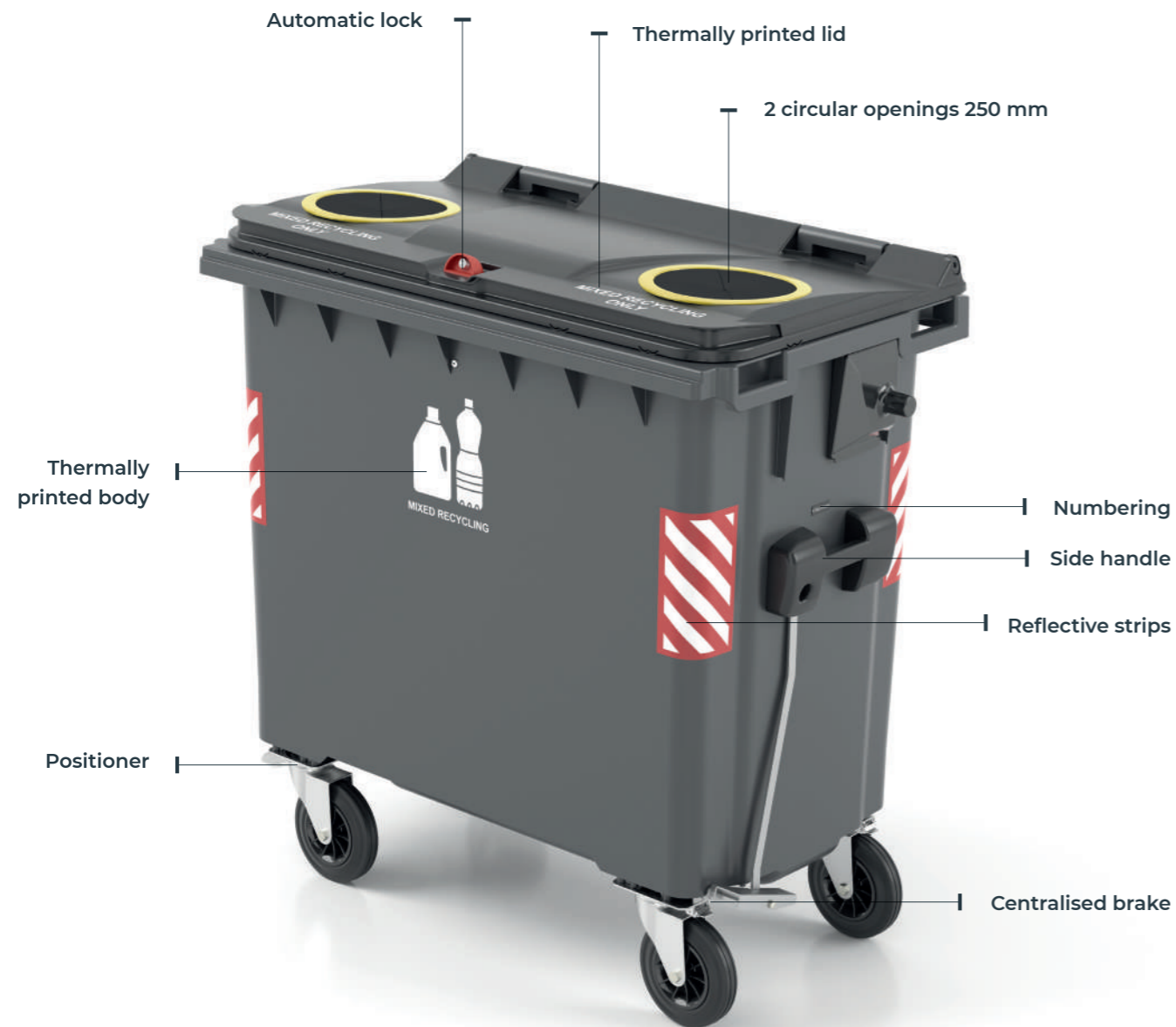

ACCESSORIES ▶

SELECTIVE OPENINGS –

** Check each model's availability*

Openings used to recycle different types of waste: paper and cardboard, glass, packaging, organic, MSW...

Circular openings, available in the following diameters:

- ▶ Ø150 mm
- ▶ Ø200 mm
- ▶ Ø250 mm
- ▶ Ø300 mm
- ▶ Ø350 mm

Rectangular openings, sizes available:

- ▶ 260 x 160 mm
- ▶ 350 x 200 mm

Paper opening, sizes available:

- ▶ 512 x 145 mm
- ▶ 524 x 150 mm
- ▶ 530 x 227 mm
- ▶ 620 x 196 mm

Brush opening, size available:

- ▶ 330 x 150 mm

Opening for confidential waste, size available:

- ▶ 300 x 35 mm
- ▶ 330 x 35 mm

MANUAL OR AUTOMATIC LOCK –

This prevents the container from opening

REFLECTIVE STRIPS –

Highly visible and adhesive

NUMBERING –

On a plate or thermally printed on the body

CUSTOMISATION –

Thermally printed on the body, maximum size 400 x 400 mm

Thermally printed on the lid, maximum size 230 x 45 mm

CUSTOMISED STICKER OR ADHESIVE VINYL –

The container's body and lid may be customised with a sticker or adhesive vinyl

SIDE HANDLE –

To facilitate container handling

CENTRALISED BRAKE –

An accessory that blocks all wheels at the same time

POSITIONER –

Used to mount the position of the container's undercarriage



ACCESSORIES ▶



PEDAL -

The pedal accessory, with or without a shock absorber, is installed in the body to facilitate lid opening. Side-pedal option available

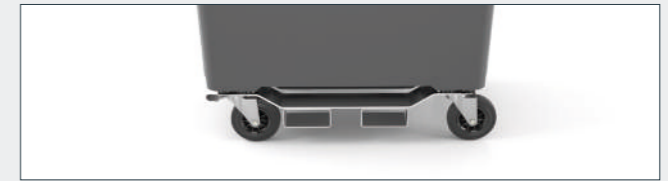

FORK POCKETS -

Mechanism to easily lift and tip the container



LID-IN-LID -

An accessory designed to preserve the selective collection of atmospheric agents and to avoid unpleasant smells. Useful size: 300 x 250 mm

Lid-in-lid options:

- ▶ Unlocked lid-in-lid
- ▶ Manually locked lid-in-lid
- ▶ Electronically locked lid-in-lid



RUBBER LID-IN-LID -

An accessory designed to preserve the selective collection of atmospheric agents and to avoid unpleasant smells. Useful size: 285 x 150 mm

Lid-in-lid options:

- ▶ Unlocked lid-in-lid



LARGE LID-IN-LID -

An accessory designed to preserve the selective collection of atmospheric agents and to avoid unpleasant smells. Useful size: 400 x 330 mm

Lid-in-lid options:

- ▶ Unlocked lid-in-lid
- ▶ Manually locked lid-in-lid
- ▶ Electronically locked lid-in-lid



ACCESSIBILITY PACK -

- ▶ Accessible body opening
- ▶ Accessibility sign
- ▶ Braille plate



TOW KITS -

Facilitates moving multiple containers at the same time



DROP FRONT -

Accessory to handle special waste more easily. Useful size: 645 x 540 mm

CLICK ON CERTAIN ITEMS
TO LEARN MORE.



OTHER CONTAINERS

REAR-LOADING ▶



CONTAINERS FOR CLINICAL WASTE OR ADR ▶

2-WHEEL FEATURES:

- ▶ **UN customisation and ADR waste marking**
 - Containers certified under standard UN 3291 Marked as follows: C240/C360 UN 50H/Y/Y/E/**/SE-0015/O/**
 - Customisation on both sides of the container body
- ▶ **Transportation**

Transportation and deposit of ADR waste according to UN 3291 regulations
- ▶ **Lock**

All containers come with a manual lock, accessed by authorised staff only
- ▶ **Handles**

A comfortable handle fitted into the container body, for easier manipulation

4-WHEEL FEATURES:

- ▶ **UN customisation and ADR waste marking**
 - Containers certified under standard UN 3291 Marked as follows: C700/C1100 UN 50H/Y/Y/E/**/SE-0015/O/**
 - Customisation on both sides of the container body
- ▶ **Transportation**

Transportation and deposit of ADR waste according to UN 3291 regulations
- ▶ **Lock**

All containers come with a manual lock, accessed by authorised staff only
- ▶ **Handles**

Two comfortable handles fitted into the sides of the container body, to facilitate manipulation
- ▶ **Wheels**
 - Possible directional blocking accessory, when the container is used in a joint towline
 - Containers may be manufactured with grey trackless wheels (as an option)

Model	C240	C360
Capacity	240 L	340 L
Nominal load	96 Kg	136 Kg
Wheel diameter	200 mm	200 mm

Model	C700	C1100
Capacity	660 L	1100 L
Nominal load	264 Kg	440 Kg
Wheel diameter	200 mm	200 mm



BIOCONTAINER ▶

FEATURES:

- ▶ Ventilation mesh at the top and bottom of the container body to facilitate the production of household compost
- ▶ Polyethylene base at the bottom of the container, allowing organic waste to be transformed into compost
- ▶ Customisation:
 - Thermally printed on the body and lid
 - Sticker or adhesive vinyl
 - Highly visible adhesive reflective strips

Capacity	120 L	140 L
Height	996 mm	1066 mm
Depth	554 mm	512 mm
Width	482 mm	485 mm

Capacity	240 L
Height	1070 mm
Depth	735 mm
Width	581 mm

HOUSEHOLD BIN ▶



FEATURES:

- ▶ Metal handle made of zinc-plated steel, allowing the lid's opening space to be adjusted and mounted
- ▶ Customised with a thermally printed body
- ▶ Customised with a sticker or vinyl on the body and lid

Capacity	35 L
Weight	1,65 Kg
Height	487 mm
Depth	244 mm
Width	326 mm

CLICK ON CERTAIN ITEMS
TO LEARN MORE.



SIDE-LOADING CONTAINERS

Designed as part of a city's landscape

CONTENUR's Side-Loading containers may be recognised by their quality, durability and resistance. They have been conceived as part of a city's landscape.

Manufactured with high-density injected polyethylene and environmentally-friendly materials, they are certified under the highest national and international quality and product standards.

An ergonomic design that is fully adaptable to each type of selective collection: paper and cardboard, glass, plastic, packaging, organic waste, other waste, etc.

Openings for loading at a lower height, sized and specifically designed for each application, for easier use. This may include **Smart Elements**, providing information in real time.

Outstanding user-friendliness and downloading, designed to ensure easy, speedy and effective cleaning and maintenance in optimum operating conditions.



INNOVATION



DESIGN



ACCESSIBILITY



CLICK ON CERTAIN ITEMS
TO LEARN MORE.



SIDE-LOADING CONTAINERS



USER LID OPENING

Equipped with a pedal to allow contactless opening of the lid.



GUIDE BARS

Plastic guide bars to reduce the noise made during collection.

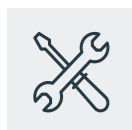

OPENING BARS

Elimination of cables to open the lid, resulting in less equipment maintenance.



SLIDERS

Elastic sliders to better adapt the container to the ground.

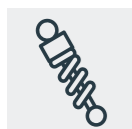

SHOCK ABSORBER

Allowing a safe and noiseless closing of the user lid.



CUSTOMISATION

Possibility of customising the container body with emblems, logos, etc. using a thermoprinting system.

CL360



- 2750 L capacity
- 124 Kg weight
- 1100 Kg nominal load
- 1195 mm loading height

Model	Capacity	Weight	Nominal load	Loading height
CL360	2750 L	124 Kg	1100 Kg	1195 mm

OVAL 2000



- 2000 L capacity
- 116 Kg weight
- 800 Kg nominal load
- 1190 mm loading height

OVAL 3000



- 3000 L capacity
- 138 Kg weight
- 1200 Kg nominal load
- 1190/1250 mm loading height

Model	Capacity	Weight	Nominal load	Loading height
OVAL 2000	2000 L	116 Kg	800 Kg	1190 mm
OVAL 3000	3000 L	138 Kg	1200 Kg	1190/1250 mm

C2200



- 2200 L capacity
- 116 Kg weight
- 880 Kg nominal load
- 1180 mm loading height

C3200 F



- 3200 L capacity
- 140 Kg weight
- 1280 Kg nominal load
- 1180 mm loading height

Model	Capacity	Weight	Nominal load	Loading height
C2200	2200 L	116 Kg	880 Kg	1180 mm
C3200 F	3200 L	140 Kg	1280 Kg	1180 mm

C2400



- 2400 L capacity
- 135 Kg weight
- 960 Kg nominal load
- 1280 mm loading height

C3200 D



- 3200 L capacity
- 146 Kg weight
- 1280 Kg nominal load
- 1263 mm loading height

Model	Capacity	Weight	Nominal load	Loading height
C2400	2400 L	135 Kg	960 Kg	1280 mm
C3200 D	3200 L	146 Kg	1280 Kg	1263 mm

CLICK ON CERTAIN ITEMS
TO LEARN MORE.



CL360

SIDE-LOADING ▶



DESIGNED FOR

CITIES

The **CL360** side-loading model is designed for a perfect integration in the city. A container model with a modern and renewed design, through soft shapes and simplified lines. As part of its CIRCLE® project, **CONTENUR** has set priorities in resource management to integrate the **CL360** container into the circular economy. The **CL360** container is 100% recyclable at the end of its useful life. Possibility of manufacturing the model with up to 100% recycled material.

Model	CL360
Capacity	2750 L
Weight	124 Kg
Nominal load	1100 Kg
Loading height	1195 mm

ACCESSORIES ▶

SELECTIVE OPENINGS -

Openings used to recycle different types of waste: paper and cardboard, glass, packaging, organic and other waste...

THERMALLY PRINTED CUSTOMISATION -

Great customisation potential on the body using thermal printing, maximum size 400x400 mm

CUSTOMISED STICKER OR ADHESIVE VINYL -

Each container may be customised with a sticker or adhesive vinyl, facilitating container access

WASTE IDENTIFICATION -

Relief sign and Braille marking for visually impaired users. Placed on the container body to indicate the type of waste

RFID CHIPS -

Space on the container body to host chips. This facilitates container identification and tracking

NUMBERING -

Using a plate on the body

WASTE IDENTIFICATION STICKER -

This facilitates citizen recycling, by including diagrams and icons for a rapid identification of each container

ACCESSIBILITY -

Opening height at 1195 mm, with little effort needed to action the pedal, which makes it fully accessible



CONTAINERS — Side-Loading ▶ CL360

ACCESSORIES ▶

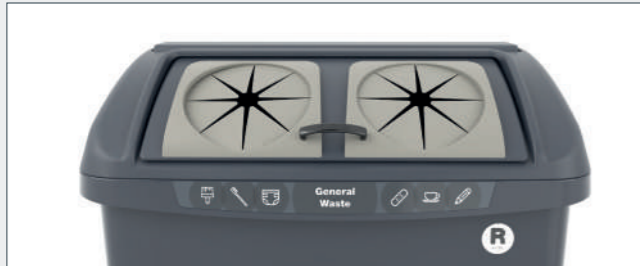

SELECTIVE OPENINGS –

Circular openings, Ø200 and Ø400, and paper opening 975 x 200 mm



PEDAL –

An integrated pedal conceived to ensure accessibility and ergonomics



NON-SELECTIVE WASTE OPENING –

Lightweight and shock-absorbing, slows down the closing of the lid to prevent harsh closures



LEVER –

A manual opening device located on the body, allowing container accessibility



AGAINST THE WALL OPTION –

It makes it easier for the user to deposit waste when the container is located in areas that are difficult to access and cannot be reached from the pavement side. Loading and unloading is carried out in the same place



ALIGNMENT SYSTEM –

This helps the container remain in the same position



MANUAL LOCK –

Manual key lock to control user access to the container



LARGE PRODUCERS SYSTEM –

Lifting system that allows waste to be dumped into large containers

CLICK ON CERTAIN ITEMS
TO LEARN MORE.



OVAL

SIDE-LOADING CONTAINERS ▶



Waste identifying sticker
Thermally printed body
Selective openings
Waste identification

FULLY INTEGRATED

INTO EACH CITY'S LANDSCAPE

Our side-loading **OVAL 2000** and **OVAL 3000** models are streamlined with a rounded design. Each unit is designed to facilitate and maximise its use, with simple lines in order to fit into the city's landscape. All containers have the same height and depth, to ensure uniform appearance in islands installed in the public thoroughfare. This generates greater homogeneity and is more space-efficient.

Model	OVAL 2000	OVAL 3000
Capacity	2000 L	3000 L
Weight	116 Kg	138 Kg
Nominal Load	800 Kg	1200 Kg
Loading Height	1190 mm	1190/1250 mm

ACCESSORIES ▶

SELECTIVE OPENINGS -

Openings used to recycle different types of waste: paper and cardboard, glass, packaging, organic and other waste...

THERMALLY PRINTED CUSTOMISATION -

Great customisation potential in the body using thermal printing, maximum size 400x400 mm

CUSTOMISED STICKER OR ADHESIVE VINYL -

Each container may be customised with a sticker or adhesive vinyl, facilitating container access

WASTE IDENTIFICATION -

Relief sign and Braille marking for visually impaired users. Placed on the container body to indicate the type of waste

RFID CHIPS -

Space on the container body to host chips. This facilitates container identification and tracking

NUMBERING -

Using a plate on the body

WASTE IDENTIFICATION STICKER -

This facilitates citizen recycling, by including diagrams and icons for a rapid identification of each container

ACCESSIBILITY -

Opening height at between 1190 and 1250 mm, involving the least possible pedal action, which makes it fully accessible



ACCESSORIES ▶

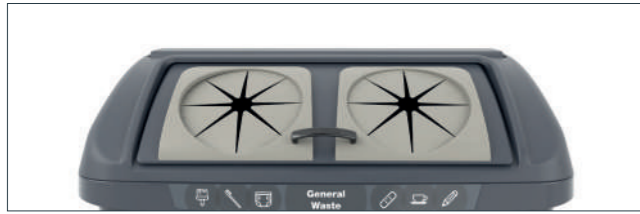

SELECTIVE OPENINGS –

** Check each Model's availability*

Circular openings, Ø200 and Ø400, and paper opening 890 x 200 mm



PEDAL –

An integrated pedal conceived to ensure accessibility and ergonomics. The maximum height of the pedal at its lowest is 250 mm from the ground



USER LID –

Light and buffered, slowing down the lowering of the lid to avoid it suddenly closing



PEDAL FLEX® –

The only pedal currently existing on the market that is compatible with a closed lock. This accessory is compatible with the body lever option



LEVER –

A manual opening device located in the body, allowing container accessibility



LARGE LID-IN-LID –

Accessory used to preserve the selective collection of atmospheric agents and avoid unpleasant smells. Useful size: 400 x 400 mm.

Lid-in-lid options:

- ▶ Unlocked lid-in-lid
- ▶ Manually locked lid-in-lid
- ▶ Electronically locked lid-in-lid



LARGE SIZE OPENING –

It simplifies the container as it does not have a pedal and maximises the deposit surface. Waste can be introduced without making contact with the container.

Dimensions:

- ▶ OVAL 2000: 370 x 410 mm
- ▶ OVAL 3000: 370 x 750 mm



AGAINST THE WALL OPTION –

It makes it easier for the user to deposit the waste when the container is located in areas that are difficult to access and cannot be reached from the pavement side. Loading and unloading is carried out in the same place



MANUAL LOCK –

Manual key lock to control user access to the container



ELECTRONIC LOCK –

Reliable and adjusted lock to reduce incidents



ALIGNMENT SYSTEM –

This helps the container remain in the same position



LARGE PRODUCERS SYSTEM –

Lifting system that allows waste to be dumped into large containers

CLICK ON CERTAIN ITEMS
TO LEARN MORE.



OVAL

100% CIRCLE® ▶

CIRCLE® ▶

This is the company's new outlook, fruit of our continuous self-achievement. It goes beyond a mere catalogue of products and services. **Circle® represents a 100% circular economy.**



ENVIRONMENT ▶

We are aware of how industry impacts the environment. We promote corporate commitment and the adoption of responsible policies. Our own activity sets an example, for a start.



ECONOMY ▶

We have thoroughly reviewed our business strategy, ensuring Circle's economic feasibility, despite the economic resources it involves. This will allow it to remain over time.



SOCIAL DYNAMICS ▶

We strive to create strategic alliances that facilitate change, generating social awareness, reducing the generation of waste and encouraging recycling.



Circle® is put into practice through products such as the OVAL container

CLICK ON CERTAIN ITEMS TO LEARN MORE.



F MODEL

SIDE-LOADING CONTAINERS ▶

ASYMMETRIC MODEL

CONTENUR's asymmetric side-loading model has two versions, with **2200** or **3200** litre capacity. The container has a modern design, with homogenous shapes and a range of colours conceived to fit into current city landscapes. Its ergonomic design is all-inclusive, ensuring 100% accessibility.

Model	C2200	C3200 F
Capacity	2200 L	3200 L
Weight	116 Kg	140 Kg
Nominal Load	880 Kg	1280 Kg
Loading Height	1180 mm	1180 mm

ACCESSORIES ▶

SELECTIVE OPENINGS –

Openings used to recycle different types of waste: paper and cardboard, glass, packaging, organic and other waste...

THERMALLY PRINTED CUSTOMISATION –

The container body may be customised using thermal printing, maximum size 400 x 400 mm

WASTE IDENTIFICATION –

Relief sign and Braille marking for visually impaired users. Placed on the container body to indicate the type of waste

RFID CHIPS –

Space in the container body to host chips. This facilitates container identification and tracking

NUMBERING –

Using a plate on the body

REFLECTIVE STRIPS –

These ensure greater container visibility in the public thoroughfare

WASTE IDENTIFICATION STRIP –

A sticker placed on the downloading lid, to identify the type of waste outside collection times

POSITION STRIP –

A sticker placed at the back of the container, to guide the collection truck during downloading

CUSTOMISED STICKER OR ADHESIVE VINYL –

Each container may be customised with a sticker or adhesive vinyl



SELECTIVE OPENINGS –

* Check each Model's availability

Circular openings, Ø200, Ø300 and Ø400. Rectangular opening for 3200 L containers, sizes available:

- ▶ 990 x 150 mm
- ▶ 1000 x 250 mm



LID-IN-LID –

Accessory designed to preserve the selective collection of atmospheric agents and to avoid unpleasant smells. Useful size: 240 x 270 mm

Lid-in-lid options:

- ▶ Unlocked lid-in-lid
- ▶ Electronically locked lid-in-lid (GPRS system)



MANUAL LOCK –

A key-operated manual lock allowing control over container user access



ELECTRONIC LOCK –

Card-operated electronic lock for user control, through GPRS or a radiofrequency system



PEDAL –

The pedal accessory is installed in the body and makes it easier to open the lid

PEDAL FLEX® –

The only pedal currently existing on the market that is compatible with a closed lock. This accessory is compatible with the body lever option



LARGE LID-IN-LID –

Accessory designed to preserve the selective collection of atmospheric agents and to avoid unpleasant smells. Useful size: 400 x 400 mm

Lid-in-lid options:

- ▶ Unlocked lid-in-lid
- ▶ Manually locked lid-in-lid
- ▶ Electronically locked lid-in-lid



LARGE PRODUCER SYSTEM –

Lifting system to empty waste held in large-size containers



ALIGNMENT SYSTEM –

It allows the container to remain in the same position



VOLUME LIMITER –

This limits the size of deposited waste and is card-operated with an electronic lock, providing a log of users, frequency of use and the amount of generated waste

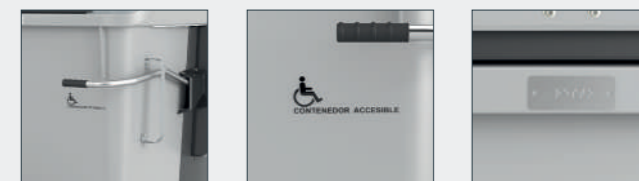

ACCESSIBILITY PACK –

- ▶ Lever
- ▶ Accessibility sign
- ▶ Braille plate

CLICK ON CERTAIN ITEMS TO LEARN MORE.



D MODEL

SIDE-LOADING CONTAINERS ▶

SYMMETRIC MODEL

CONTENUR's symmetric side-loading container is resistant, durable, functional and easy to handle. With capacity of **2400** and **3200** litres, both models allow downloading on both sides. The small number of parts and components included ensure efficient maintenance. Manufactured with injected PE and designed to avoid deformities, to meet load requirements and to withstand blows during manipulation.

Model	C2400	C3200 D
Capacity	2400 L	3200 L
Weight	135 Kg	146 Kg
Nominal Load	960 Kg	1280 Kg
Loading Height	1280 mm	1263 mm

ACCESSORIES ▶

SELECTIVE OPENINGS -

Openings used to recycle different types of waste: paper and cardboard, glass, packaging, organic and other waste...

THERMALLY PRINTED CUSTOMISATION -

The container may be customised through thermal printing, maximum size 400 x 400 mm

WASTE IDENTIFICATION -

Relief sign and Braille marking for visually impaired users. Place on the container body to indicate the type of waste

CHIP HOSTING -

Space inside the container body to host chips. This facilitates container identification and tracking

NUMBERING -

Using a plate on the body

REFLECTIVE STRIPS -

These ensure more container visibility in the public thoroughfare

POSITION STRIP -

A sticker place at the back of the container, to guide rubbish collectors during downloading



SELECTIVE OPENINGS

** Check each Model's availability*

Circular openings, Ø200, Ø250, Ø300 and Ø400.

Rectangular opening for 2400 L containers, sizes available:

- ▶ 485 x 185 mm
- ▶ 1000 x 190 mm
- ▶ 1000 x 225 mm
- ▶ 1090 x 190 mm

Rectangular opening for 3200 L containers, sizes available:

- ▶ 1015 x 150 mm
- ▶ 1090 x 180 mm



REVERSIBLE PEDAL -

Two-height pedal for adjustment depending on where the container is located



LID-IN-LID -

Accessory designed to preserve the selective collection of atmospheric agents and to avoid unpleasant smells.

- ▶ Useful size (2400 L): 240 x 270 mm
- ▶ Useful size (3200 L): 325 x 320 mm

Lid-in-lid options: unlocked lid-in-lid



LARGE LID-IN-LID -

Accessory designed to preserve the selective collection of atmospheric agents and to avoid unpleasant smells.

Useful size: 400 x 400 mm

Lid-in-lid options:

- ▶ Manually locked lid-in-lid
- ▶ Electronically locked lid-in-lid



ALIGNMENT SYSTEM -

This ensures that the container remains in the same position



LEVER -

A manual opening system located in the body, to facilitate container accessibility

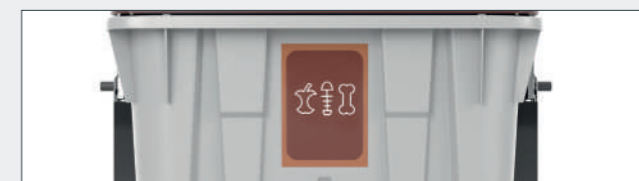

CUSTOMISED STICKER OR ADHESIVE VINYL -

Each container may be customised with a sticker or adhesive vinyl, facilitating container accessibility



ACCESSIBILITY PACK -

- ▶ Accessible body opening
- ▶ Accessibility sign
- ▶ Braille plate

CLICK ON CERTAIN ITEMS
TO LEARN MORE.



CRANE-LIFT

RANGE ▶

Perfect for selective collection

CONTENUR's crane-lift range are manufactured through rotomoulding, with high-density linear polyethylene dyed in the mass and stabilised to fight the combined action of water and UV rays, extending their useful life and generating a highly resistant product to atmospheric agents.

These containers are manufactured under the highest international standards, and hold strict quality and product certifications.

Conceived to easily fit into the city's landscape, offering specific solutions for each type of waste. Available in a wide range of colours, with a full set of accessories to resolve any incident that may arise in each city's waste collection. Different lifting systems available: regular hook, double hook or Kinshofer.

Thanks to its manufacturing system, materials and design, little maintenance is required.



INTEGRATED INTO
THE CITY LANDSCAPE



SUSTAINABILITY



EASILY EMPTIED

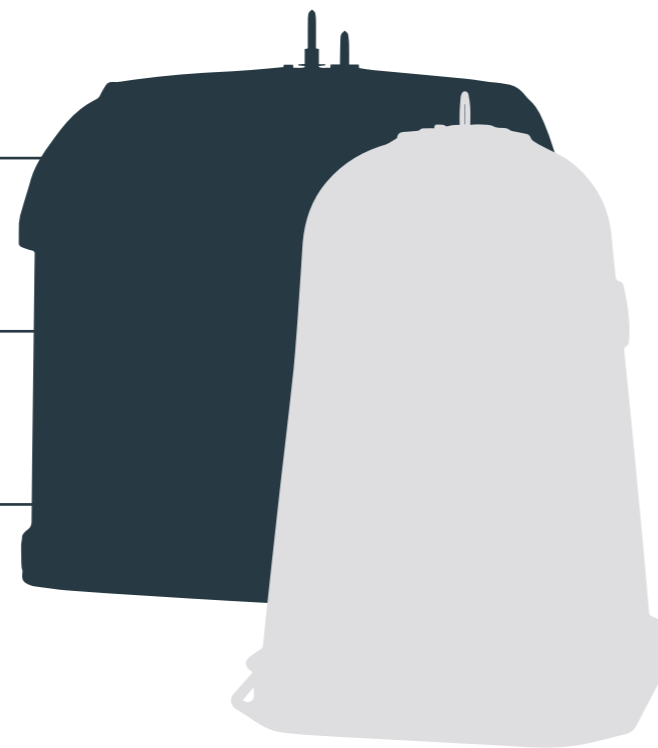

CRANE-LIFT

RANGE ▶



MANUFACTURING

Manufactured using a rotomoulding system with high-density linear polyethylene, extending its useful life.



LIFTING SYSTEM

Anti-rust metal lifting system. Available for different systems: regular hook, double hook and Kinshofer.



DESIGN

Conceived for full integration into city and rural areas, offering specific solutions for each type of waste.



CUSTOMISATION

Crane-Lift – Bilateral-Loading containers may be customised with emblems, logos, etc., by placing a sticker or adhesive vinyl.



CERTIFICATION

All Crane-Lift – Bilateral-Loading containers are designed and manufactured further to EN-13071 quality standards.



EFFICIENT MAINTENANCE

Crane-Lift – Bilateral-Loading containers require little maintenance thanks to their manufacturing system, materials and design. Their small number of parts and components ensure efficient maintenance.

Model	Capacity	Unladen Weight	Maximum Load	Total Height	Opening Height	Lifting system
360IGLOO	3000 L	150 Kg	1200 Kg	1475 mm	1195 mm	Double hook / Kinshofer / F-90
OVAL Igloo	3000 L	140 Kg	1200 Kg	1600 mm	1190 mm 1250 mm	Double hook / Kinshofer
OPTIK Igloo	2000 L 3000 L 4000 L	207 Kg 246 Kg 285 Kg	800 Kg 1200 Kg 1600 Kg	1889 mm	1200 mm 1500 mm	Regular hook / Double hook / Kinshofer
2 Side System Igloo	2000 L 2800 L 3600 L	130 Kg 161 Kg 179 Kg	800 Kg 1120 Kg 1440 Kg	1600 mm	1180 mm	Double hook / Kinshofer
Circular Igloo	2500 L 3000 L	90 Kg 102 Kg	625 Kg 750 Kg	1700 mm	1400 mm 1420 mm	Double hook / Kinshofer
Rectangular Igloo	2500 L	120 Kg	625 Kg	1827 mm	1400 mm	Double hook / Kinshofer
Agora Igloo	2700 L	180 Kg	1080 Kg	1665 mm	1357 mm	Double hook / Kinshofer
3200 Igloo	3200 L	213 Kg	1280 Kg	1727 mm	1314 mm	Double hook / Kinshofer
Cite Igloo	2200 L	140 Kg	880 Kg	1854 mm	1200 mm 1463 mm	Double hook / Kinshofer
Metallic Igloo	3000 L	268 Kg	750 Kg	1620 mm	1300 mm	Double hook / Kinshofer

CLICK ON CERTAIN ITEMS
TO LEARN MORE.



360IGLOO



- Double hook / Kinshofer / F-90
- 3000 L capacity
- 1200 Kg nominal load
- 1195 mm Opening Height

OVAL IGLOO



- Double hook / Kinshofer
- 3000 L capacity
- 1200 Kg nominal load
- 1190 - 1250 mm Opening Height

OPTIK IGLOO 2000



- Regular hook / Double hook / Kinshofer
- 2000 L capacity
- 800 Kg nominal load
- 1200 - 1500 mm Opening Height

2 SIDE SYSTEM IGLOO- 2000 L



- Double hook / Kinshofer
- 2000 L capacity
- 800 Kg nominal load
- 1180 mm Opening Height

OPTIK IGLOO 3000



- Regular hook / Double hook / Kinshofer
- Capacidad 3000 L
- 1200 Kg nominal load
- 1200 - 1500 mm Opening height

2 SIDE SYSTEM IGLOO- 2800 L



- Double hook / Kinshofer
- 2800 L capacity
- 1120 Kg nominal load
- 1180 mm Opening Height

OPTIK IGLOO 4000



- Regular hook / Double hook / Kinshofer
- 4000 L capacity
- 1600 Kg nominal load
- 1200 - 1500 mm Opening height

2 SIDE SYSTEM IGLOO- 3600 L



- Double hook / Kinshofer
- 3600 L capacity
- 1440 Kg nominal load
- 1180 mm Opening Height

CRANE-LIFT RANGE ▶

CIRCULAR IGLOO



- Double hook / Kinshofer
- 2500 L capacity
- 625 Kg nominal load
- 1400 mm Opening Height

RECTANGULAR IGLOO



- Double hook / Kinshofer
- 2500 L capacity
- 625 Kg nominal load
- 1400 mm Opening Height

AGORA IGLOO



- Double hook / Kinshofer
- 2700 L capacity
- 1080 Kg nominal load
- 1200 mm Opening Height

3200 IGLOO



- Double hook / Kinshofer
- 3200 L capacity
- 1280 Kg nominal load
- 1314 mm Opening Height

CITE IGLOO



- Double hook / Kinshofer
- 2200 L capacity
- 880 Kg nominal load
- 1200 - 1463 mm Opening Height

METALLIC IGLOO



- Double hook / Kinshofer
- 3200 L capacity
- 750 Kg nominal load
- 1300 mm Opening Height

CLICK ON CERTAIN ITEMS
TO LEARN MORE.



360IGLOO

CRANE-LIFT RANGE ▶



ACCESSORIES ▶



NON-SELECTIVE WASTE OPENING -

Lightweight and shock-absorbing, slows down the closing of the lid to prevent harsh closures



WASTE IDENTIFICATION -

Relief sign and Braille marking for visually impaired users. Placed on the container body to indicate the type of waste

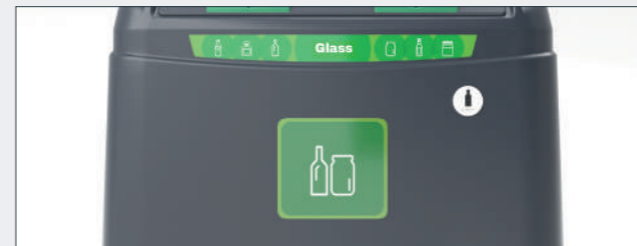

CUSTOMISATION WITH STICKERS OR ADHESIVE VINYL -

Large customisation area on the body for logos and waste recycling instructions as well as on the front and rear edge

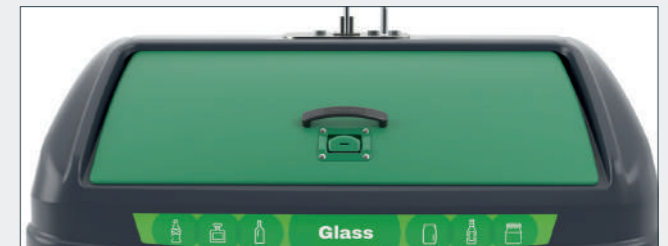

MANUAL LOCK -

Manual key lock to control user access to the container



LARGE PRODUCERS SYSTEM -

Lifting system that allows waste to be dumped into large containers



CUSTOMISATION BY HOT STAMPING -

Large customisation area on the body for hot stamping, maximum size 400x400 mm

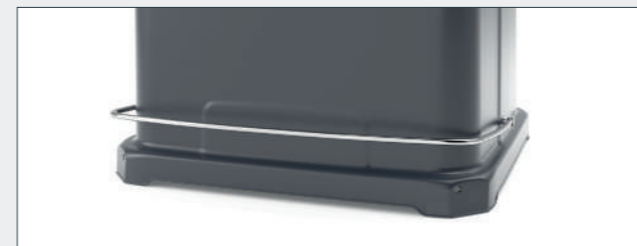

PEDAL -

An integrated pedal conceived to ensure accessibility and ergonomics



ACCESSORIES ▶



SELECTIVE OPENINGS –

Openings used to recycle different types of waste: paper and cardboard, glass, packaging, organic and other waste...

Circular openings, available diameters:

- ▶ Ø200 mm
- ▶ Ø400 mm

Paper opening, available dimensions: 975 x 200 mm



AGAINST THE WALL OPTION –

It makes it easier for the user to deposit waste when the container is located in areas that are difficult to access and cannot be reached from the pavement side. Loading and unloading is carried out in the same place

CLICK ON CERTAIN ITEMS
TO LEARN MORE.



OVAL IGLOO

CRANE-LIFT RANGE ▶



ACCESSORIES ▶



USER LID –

Light and buffered, slowing down the lowering of the lid to avoid a sudden closure. Available for different fractions



WASTE IDENTIFICATION –

Relief sign and Braille marking for visually impaired users. Placed on the container body to indicate the type of waste



CUSTOMISED STICKER OR ADHESIVE VINYL –

Large customisation potential in the body for logos and waste recycling instructions, to include the front and back edge



COVERED SELECTIVE OPENINGS –

Accessory designed to prevent water seeping into the container. It guarantees uniformity in island design

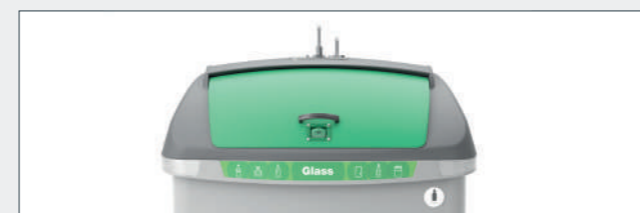

MANUAL LOCK–

Preventing the container from opening



ELECTRONIC LOCK –

Reliable and fitted lock to reduce incidents



ACCESSORIES ▶



SELECTIVE OPENINGS –

Used to recycle different types of waste: glass, paper and cardboard, packaging, MSW...

Circular openings, diameters available:

- ▶ Ø200 mm
- ▶ Ø400 mm

Paper opening, size available: 890 x 210 mm

Large lid-in-lid, useful size: 400 x 400 mm



DOUBLE LID IN LID –

User lid made up of two big sized lid in lids. Specially designed for recyclable and non-recyclable waste. Dimensions of each lid in lid: 400 x 400 mm



LARGE-PRODUCER SYSTEM –

System to help the emptying of large-producer containers, facilitating the deposit of waste

CLICK ON CERTAIN ITEMS
TO LEARN MORE.



OPTIK IGLOO

CRANE-LIFT RANGE ▶



ACCESSORIES ▶



VOLUME –

Designed to recycle glass, packaging, paper, organic matter and organic waste

Three volume options: 2m³, 3m³, 4m³



PEDAL –

** Only available for regular hook lifting systems*

Emptying door fitted with a pedal to activate the downloading door, allowing the container to be fully emptied



SELECTIVE OPENINGS –

Possibility of user openings on all four sides: two on the front and back, and one on each side.

Circular openings (packaging and glass): Ø180 mm

Rectangular opening (packaging and paper): 350 x 150 mm

Large lid-in-lid (waste and organic matter): useful size, 330 x 400 mm

Rectangular opening (paper). Available dimensions:

- ▶ 2m³: 600 x 150 mm
- ▶ 4m³: 1000 x 150 mm; 1000 x 200 mm; 1000 x 350mm

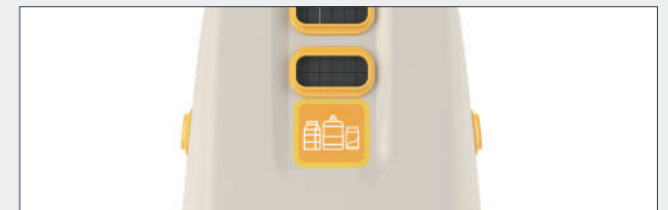

CUSTOMISED STICKER OR ADHESIVE VINYL –

Large areas for customisation, using logos and waste instructions.

- ▶ Front and back, sizes available:
 - 420 x 320 mm
 - 420 x 630 mm
- ▶ Side: max. size 500 x 600 mm



VOLUMETRIC BOX –

Accessory that limits the volume of waste introduced at each use



ACCESSIBLE OPENINGS –

User openings at different heights for greater accessibility.

- ▶ Front and back: 1200 mm and 1500 mm
- ▶ Side: 900 mm

CLICK ON CERTAIN ITEMS
TO LEARN MORE.



2SIDE SYSTEM® IGLOO

CRANE-LIFT RANGE ▶



ACCESSORIES ▶



VOLUME –

Three volume options available:

- ▶ 2000 L
- ▶ 2800 L
- ▶ 3600 L



SELECTIVE OPENINGS –

Openings used to recycle different types of waste: paper and cardboard, glass, packaging, organic and other waste...

- ▶ Circular openings Ø200 and Ø350 mm
- ▶ Rectangular opening 900 x 200 mm



USER LID –

Equipped with a pedal to allow contactless opening of the lid. Sizes available:

- ▶ 400 x 400 mm
- ▶ 650 x 400 mm



PEDAL –

CONTENÜR-patented hood design preventing the pedal from protruding over the sides



MANUAL LOCK –

This allows the user lid to be opened with a key-operated manual lock



CUSTOMISATION –

Each igloo may be customised with a sticker, facilitating citizen recycling by including pictures and icons to rapidly identify each container

Sizes available:

- ▶ 445 x 480 mm
- ▶ 795 x 480 mm
- ▶ 1145 x 480mm

CLICK ON CERTAIN ITEMS
TO LEARN MORE.



CIRCULAR IGLOO

CRANE-LIFT RANGE ▶



ACCESSORIES ▶



SELECTIVE OPENINGS –

Circular openings for packaging and glass fractions, diameters available:

- ▶ Ø200 mm
- ▶ Ø250 mm

Rectangular opening, sizes available:

- ▶ 410 x 150 mm
- ▶ 435 x 260 mm



LARGE-PRODUCER SYSTEM –

A system used to help empty large-producer containers, facilitating waste deposit

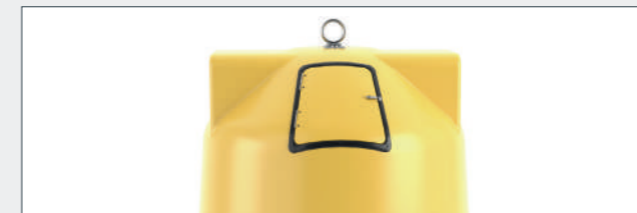

PROFESSIONAL DOOR –

An accessory exclusive designed for the services sector, facilitating waste deposit



CUSTOMISED STICKER OR ADHESIVE VINYL –

Each igloo may be customised with a sticker or adhesive vinyl



REFLECTIVE STRIPS –

Highly visible and adhesive

CLICK ON CERTAIN ITEMS
TO LEARN MORE.



RECTANGULAR IGLOO

CRANE-LIFT RANGE ▶



ACCESSORIES ▶



SELECTIVE OPENINGS –

Circular openings for packaging and glass fractions, sizes available:

- ▶ Ø200 mm
- ▶ Ø250 mm

Rectangular openings, sizes available:

- ▶ 410 x 150 mm
- ▶ 780 x 150 mm
- ▶ 925 x 150 mm



LARGE-PRODUCER SYSTEM –

A system to help the emptying of large-producer containers, to facilitate waste deposit

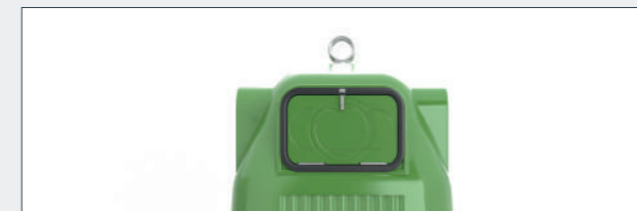

PROFESSIONAL DOOR –

An accessory exclusively designed for the services sector, to facilitate waste deposit.

Size available: 455 x 270 mm

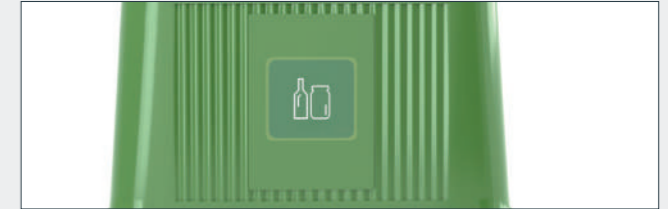

CUSTOMISED STICKER OR ADHESIVE VINYL –

Each igloo may be customised with a sticker or adhesive vinyl



REFLECTIVE STRIPS –

Highly visible and adhesive



ACCESSIBILITY PACK –

- ▶ Accessible opening in the body
- ▶ Accessibility sign
- ▶ Braille plate

CLICK ON CERTAIN ITEMS
TO LEARN MORE.



AGORA IGLOO

CRANE-LIFT RANGE ▶



ACCESSORIES ▶



SELECTIVE OPENINGS –

Circular openings for packaging and glass fractions, available diameters:

- ▶ Ø200 mm
- ▶ Ø300 mm

Rectangular opening for the paper fraction, size available: 700 x 150 mm



LARGE-PRODUCER SYSTEM –

A system to help the emptying of large-producer containers, to facilitate waste deposit



PROFESSIONAL DOOR –

An accessory exclusively designed for the services sector, to facilitate waste deposit



CUSTOMISED STICKER OR ADHESIVE VINYL –

Each igloo may be customised with a sticker or adhesive vinyl, maximum size 320 x 760 mm



ACCESS FOR KIDS –

An accessory allowing kids to access the container, encouraging their participation in waste recycling

CLICK ON CERTAIN ITEMS
TO LEARN MORE.



3200L IGLOO

CRANE-LIFT RANGE ▶



ACCESSORIES ▶



SELECTIVE OPENINGS –

Circular openings, for packaging and glass fractions, sizes available:

- ▶ Ø200 mm
- ▶ Ø250 mm
- ▶ Ø300 mm (front area)

Rectangular opening for the paper fraction, size available: 780 x 150 mm

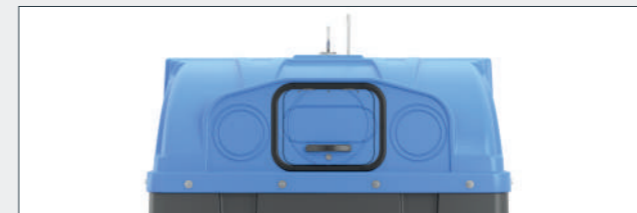

PROFESSIONAL DOOR –

An accessory exclusively designed for the services sector, to facilitate waste deposit



CUSTOMISED STICKER OR ADHESIVE VINYL –

Each igloo may be customised with a sticker or adhesive vinyl



REFLECTIVE STRIPS –

Highly visible and adhesive

CLICK ON CERTAIN ITEMS
TO LEARN MORE.



METALLIC IGLOO

CRANE-LIFT RANGE ▶



ACCESSORIES ▶



SELECTIVE OPENINGS –

Circular openings for packaging and glass fractions, diameters available:

- ▶ Ø250 mm
- ▶ Ø300 mm

Rectangular opening for the paper fraction, size available: 1000 x 180 mm

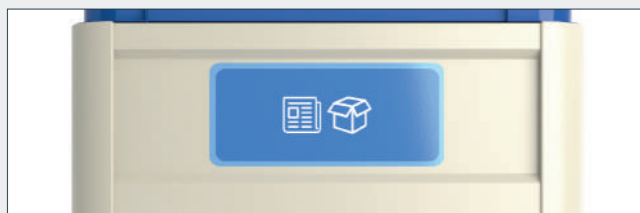

CUSTOMISED STICKER OR ADHESIVE VINYL –

Each igloo may be customised with a sticker or adhesive vinyl



CUSTOMISATION –

Customisation potential in container bodies, by printing the front and back.

Front area, maximum sizes available:

- ▶ 1240 x 140 mm
- ▶ 1240 x 170 mm
- ▶ 1240 x 240 mm

Back area, maximum size: 850 x 240 mm

CITE IGLOO

CRANE-LIFT RANGE ▶



ACCESSORIES ▶



SELECTIVE OPENINGS –

Circular openings exclusively designed for recycling of the glass fraction, available diameter:

- ▶ Ø150 mm



ACCESSIBLE OPENING –

Two openings located at a height of 1200 mm for greater accessibility



EMPTYING DOORS –

Anti-rust metal emptying system



CUSTOMISED WITH A STICKER OR ADHESIVE VINYL –

Each igloo may be customised with a sticker or adhesive vinyl

UNDERGROUND CONTAINERS

▶ CRANE-LIFT SYSTEM

▶ HYDRAULIC SYSTEM

▶ SIDE-LOADING SYSTEM

▶ DISPOSAL COLUMNS

CLICK ON CERTAIN ITEMS
TO LEARN MORE.



UNDERGROUND CONTAINERS

Innovating and safe solutions

CONTENUR's underground containers have a recognisable **design, resistance and versatility.**

Designed to totally fit into city landscapes, historic centres included, as they are conceived for large storage capacity using the least possible space in the public thoroughfare. Modular and versatile, with potential to combine plastic and metal solutions.

Safety is guaranteed as they are fitted with safety platforms, whilst remaining environmentally-friendly.

Designed to guarantee efficient collection and hygiene, as they are very easily cleaned. Underground containers allow waste to be stored below the surface, helping reduce smells, avoiding access to the waste and reducing vandalism.



RESISTANCE



VERSATILITY



ACCESSIBILITY

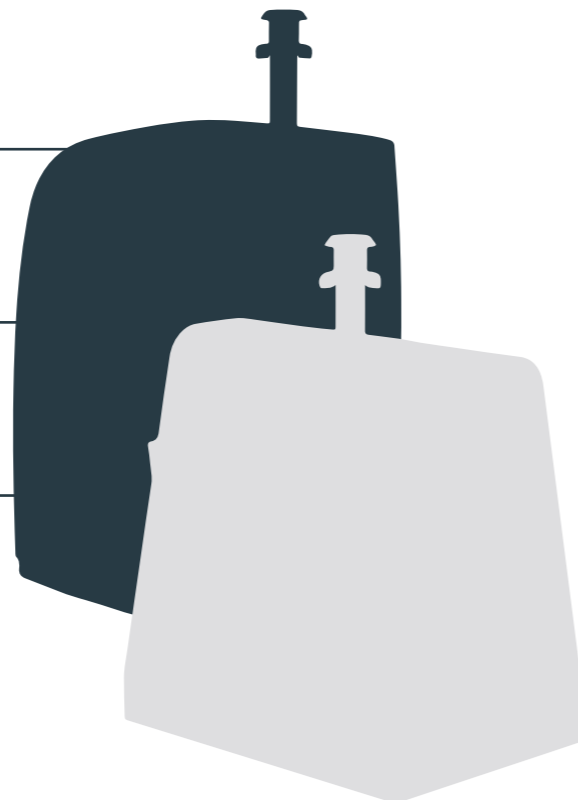

CLICK ON CERTAIN ITEMS
TO LEARN MORE.



CRANE-LIFT SYSTEM

Our Crane-Lift underground containers are conceived to improve waste downloading and to reduce maintenance, thanks to their small number of parts. This system helps citizens in their waste deposit task, and is accessible to all users.

Product certified under standards UNE EN 13071 1,2,3:2008, awarded by an external certifying company and validated by ENAC (Urban Fixture Product Standards).

LIFTING SYSTEM –

An anti-rust metal lifting system, available for different collection systems: ordinary hook, double hook, triple hook and Kinshofer.

DISPOSAL COLUMN –

The disposal column is used to deposit the waste.

CONTENUR offers a wide range of different models that adapt to each type of waste collection. Manufactured in different materials: galvanised steel, stainless steel and polyethylene.

PEDESTRIAN PLATFORM –

A pedestrian platform is manufactured in hot-galvanised anti-slip diamond plate sheet metal, or with a double cover, for mounting on the pavement.

CONTAINER –

The following volumes are available for this underground system: 3m³, 4m³ and 5m³.

All underground containers are made of galvanised steel or PEHD.

SAFETY PLATFORM –

The system includes a safety platform made of galvanised steel, which lifts automatically when the container is in a downloading position. The platform avoid falls at a height, whether by downloading or equipment maintenance staff, or citizens.

PREFABRICATED CONCRETE –

Manufactured according to standard EN-206-1, as a single reinforced and highly resistant concrete block. Prefabricated concrete is highly resistant to earth forces, and is totally airtight and waterproof.

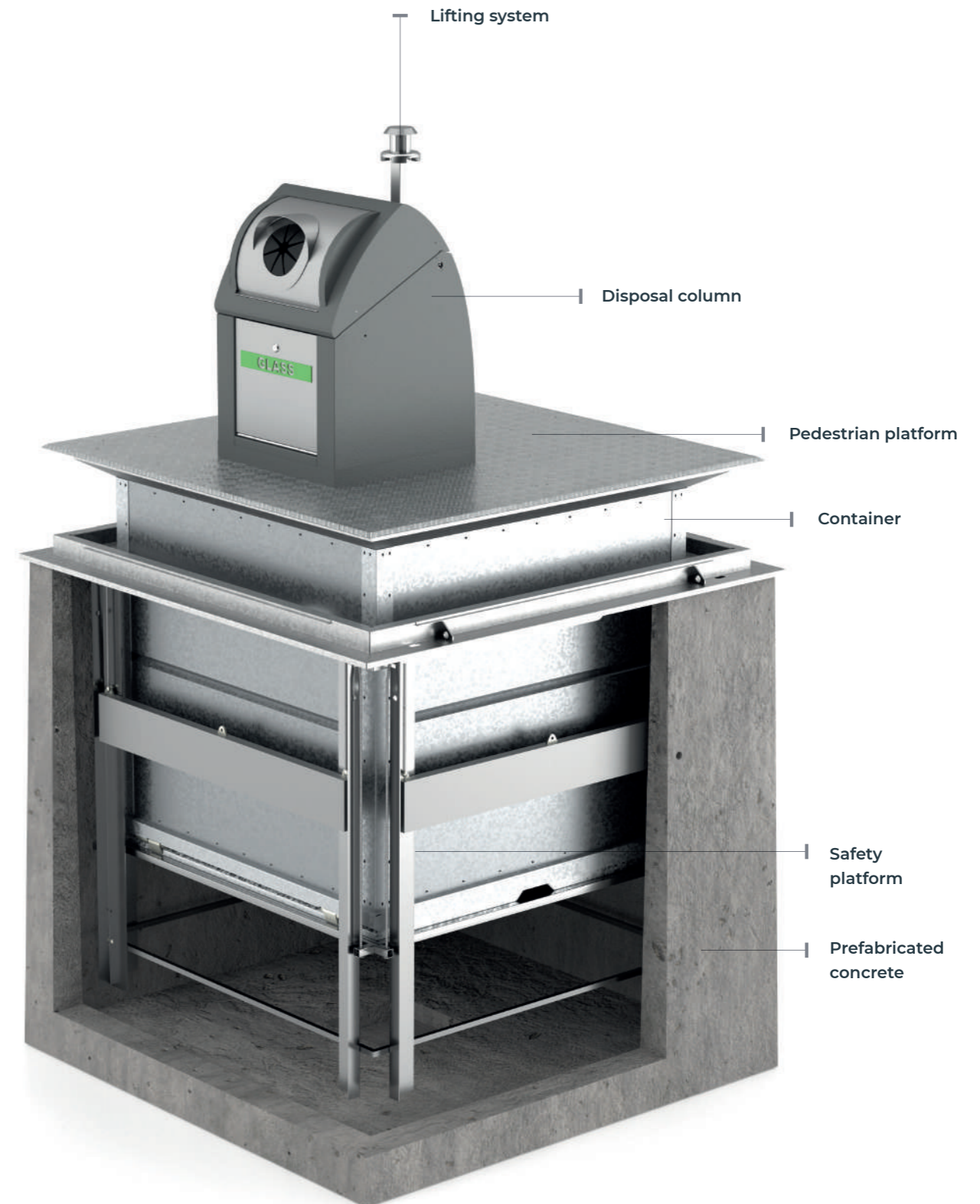

CLICK ON CERTAIN ITEMS
TO LEARN MORE.



HYDRAULIC SYSTEM

All Rear-Loading underground containers are conceived for city centres, avoiding the impact of visible waste and generating cleaner and open space. They may host up to 2, 3 or 4 Rear-Loading containers with capacity of up to 1100 L.

CONTENUR's RLSs are characteristically highly resistant and easy to maintain. They have been designed to withstand continued use in a hostile environment and have a useful life of more than 15 years. RLS equipment may be operated through a fast collector truck or an independent hydraulic central system.

DISPOSAL COLUMN -

The disposal column is where users deposit the waste. **CONTENUR** offers a large number of different models, adapted to each type of waste collection and manufactured in different materials: galvanised steel, stainless steel or polyethylene.

PEDESTRIAN PLATFORM -

This structural component bears pavement weight and road traffic. It hinders incoming liquid or rainwater and avoids smells.

The platform's standard finishing is made of anti-slip diamond plate sheet metal. It may also be adapted for similar appearance to the surrounding pavement.

LIFTING SYSTEM -

The hydraulic lifting system has a partitioned section where rear-loading containers are located. The unit is designed to position containers at street level, thus facilitating downloading and emptying.

The hydraulic system has a scissor lift, enabling progressive lifting on both sides of the platform. The structure is raised through 2 hydraulic cylinders, providing overall resistance and stability. Equipped with two parachute safety valves that protect and prevent the equipment from falling during maintenance tasks.

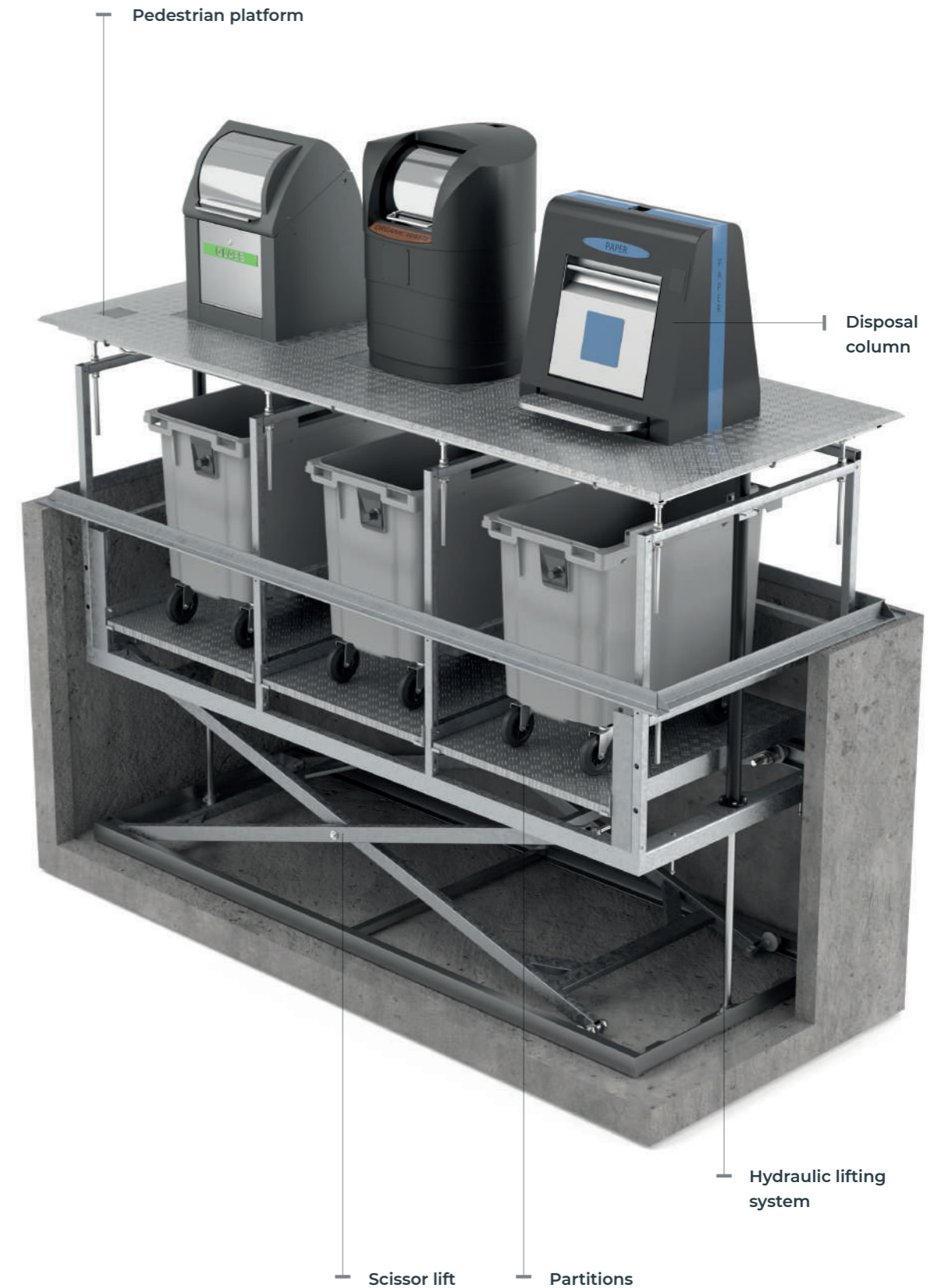

CLICK ON CERTAIN ITEMS
TO LEARN MORE.



SIDE-LOADING SYSTEM

CONTENUR's Side-Loading underground containers system is conceived for busy public areas that already have a Side-Loading container collection system. These units may hold 1 or 2 side-loading containers with capacity of up to 3200 L.

The unit is operated through an independent hydraulic central station that is activated remotely. This remote control is compatible with rear-loading equipment, and may be used for both systems.

Furthermore, the unit is fitted with a light and sound safety system, which turns on when the system is in a downloading position.

DISPOSAL COLUMN –

CONTENUR has different disposal column models that adapt to each type of collected waste and are made of different materials: galvanised steel, stainless steel or polyethylene.

PEDESTRIAN PLATFORM –

The upper or pedestrian platform bears the pavement weight and road traffic. It hinders incoming liquid or rainwater and avoids smells. The platform's standard finish is made of anti-slip diamond plate sheet metal, but may also be adapted to have a similar appearance to the surrounding pavement.

LIFTING SYSTEM –

The hydraulic lifting system has a bottom platform where the side-loading containers are located, of adjustable height. The platform has regulators to absorb any incline in the street, up to 6%.

The hydraulic system has a scissor lift to ensure progressive lifting on both sides of the platform. The structure is raised through 2 hydraulic cylinders, providing overall resistance and stability.

Equipped with parachute safety valves to protect and prevent the unit from falling during maintenance tasks.

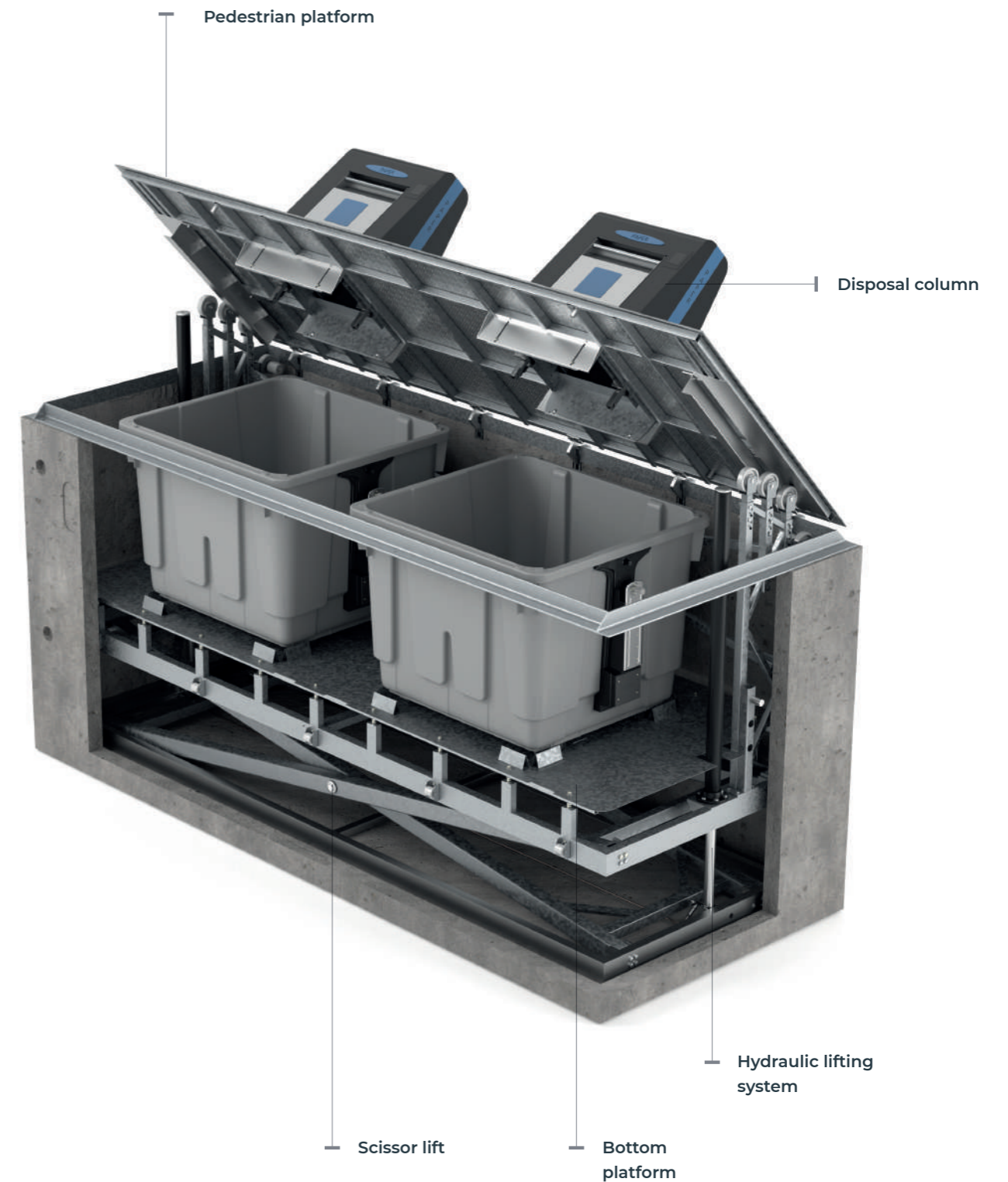

CLICK ON CERTAIN ITEMS
TO LEARN MORE.



DISPOSAL COLUMNS



DESIGN

Designed to totally fit into city landscapes, historic centres included.



CUSTOMISATION

Large customisation potential on the body of the disposal column, with different colours, logos, vinyl, informative campaigns, etc.



EFFICIENCY

CONTENUR's underground containers guarantee efficient collection and hygiene, as they are easily cleaned.



ACCESSIBILITY

Waste deposit opening at a height of 900 mm, making the unit fully accessible.



SAFETY

The safety of both citizen and cleaning and maintenance staff is guaranteed, as they are fitted with safety platforms.



CERTIFIED

They are certified under the highest quality and product standards. Productive process certified under UNE EN ISO 9001 and UNE EN ISO 14001 standards. Product certification under UNE EN 13071 standard.

Model	Height	Capacity	Volume Restrictor	Access opening (always in stainless steel)	Accessories	Material
Kheops	970 mm	40 L, 60 L, 80 L, 100 L, 120 L	Box with a restrictor	Organic waste / Packaging Paper and cardboard / Glass	Opening Ø200 mm / Pedal / Check valve / Filling control / Access control	Stainless steel / Hot galvanised steel + cataphoresis + paint
Evolution	952 mm	60L, 80 L, 100 L, 120 L	Single and double drum	Organic waste / Packaging Paper and cardboard / Glass	Opening Ø200 - 300mm / Pedal / Check valve / Filling control / Access control	Stainless steel / Hot galvanised steel + cataphoresis + paint
Europa	1100 mm	60 L, 80 L	Single and double drum	Organic waste / Packaging Paper and cardboard / Glass	Opening Ø200 mm / Check valve / Filling control	Polyethylene / inside made of pre-galvanised steel
Milenium	1110 mm	60 L, 80 L	Single and double drum	Organic waste / Packaging Paper and cardboard / Glass	Opening Ø200 - 300mm / Check valve / Filling control	Polyethylene / inside made of pre-galvanised steel
Minim	1101 mm		No limit	SUW / Packaging / Paper and cardboard / Glass	Opening Ø200 mm / Opening Ø380 / Check valve	Stainless steel / Galvanised steel + primer + paint

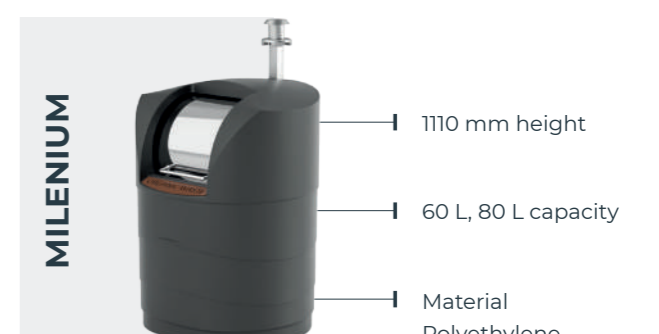
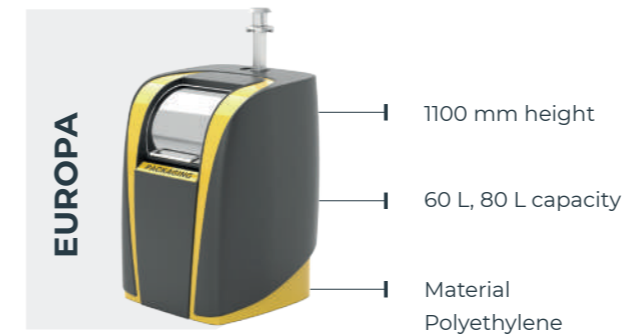
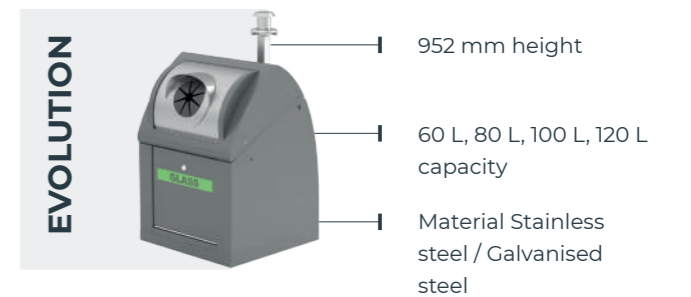
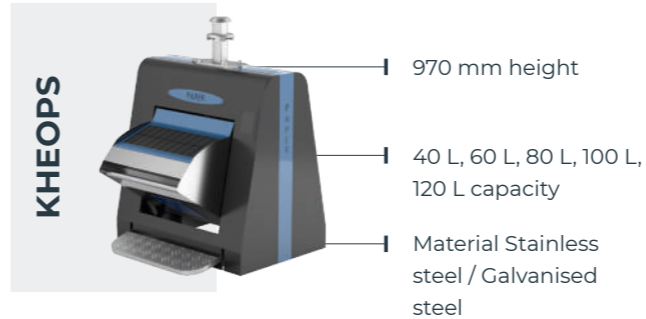

CLICK ON CERTAIN ITEMS
TO LEARN MORE.



KHEOPS

DISPOSAL COLUMNS ▶

MODULAR AND ERGONOMIC

The Kheops disposal column is made of stainless steel for greater durability and anti-rust capacity. The disposal column's measurements ensure that it occupies little street space.

The product has been designed for its full integration into any surroundings, with a total height of 970 mm, making it user-friendly and fully accessible. It is specifically designed to host smart components, sensors and locks.

The disposal column may be customised with logos and waste instructions, to facilitate citizen recycling.

Also, waste identification plates may be added and different colours are available for each fraction. Upon request, the container may be fitted with a sensor to detect the filling level and to optimise collection routes.

Its modular and simplified design facilitates maintenance and the installation of spare parts. It consists of a professional door to facilitate access by large producers and authorised staff, if the container needs to be handled.

Thanks to its small number of components, it may be easily dismantled and maintenance is simple and efficient.

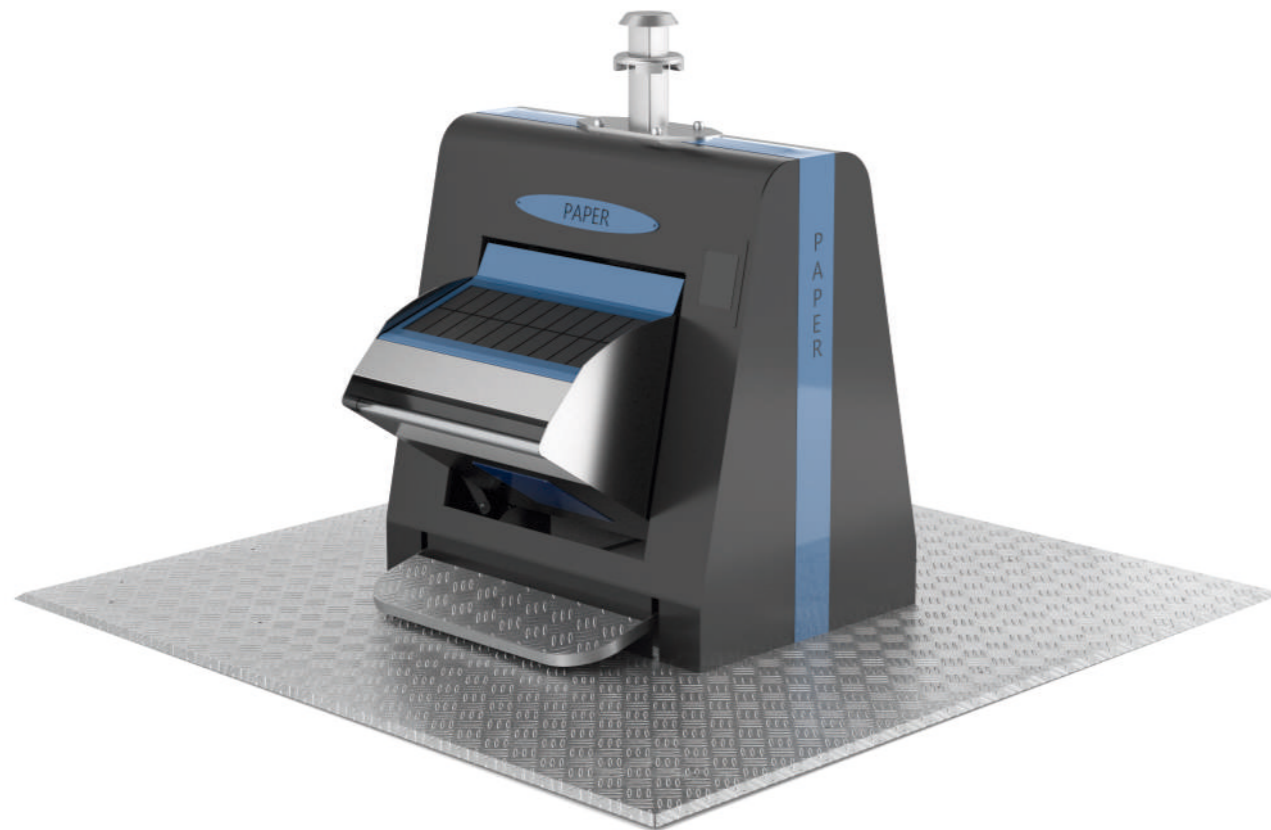

ACCESSORIES ▶

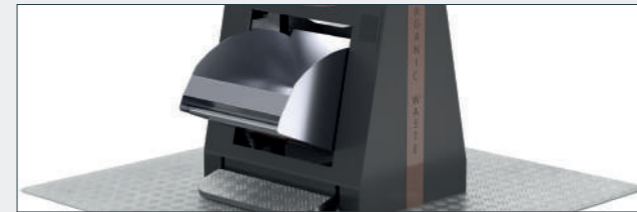

SINGLE BOX –

Box capacity of up to 120 L. Fitted with a shock absorber system to help opening and closing the door, in a noiseless manner

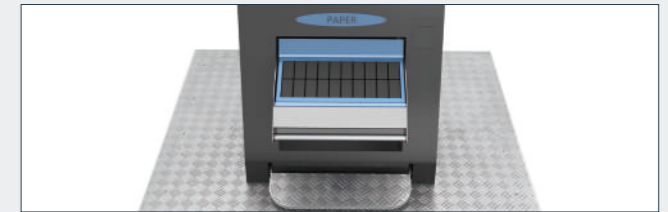

CHECK VALVE –

Integrated into the box, for the recycling of paper and packaging. Fitted with an anti-splash rubber protector. Size available: 510 x 200 mm

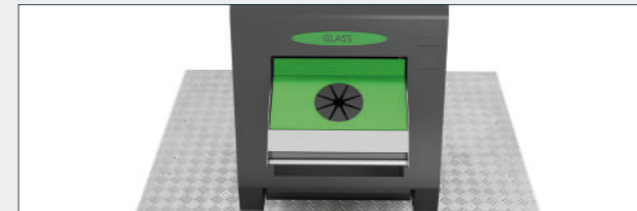

SELECTIVE OPENING –

Selective opening for glass recycling, integrated into the box. Available opening diameter 200 mm

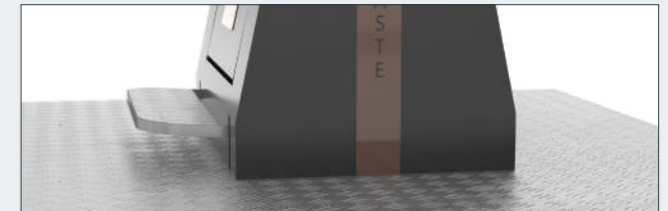

PEDAL –

Made of galvanised steel. An ergonomic pedal to facilitate effortless dropbox access. More hygienic, with a contactless container



RESTRICTOR BOX –

To limit box capacity. An access control system may be incorporated upon request



ACCESS CONTROL –

Card-operated control for user access: log, frequency of use, amount of waste generated, etc.

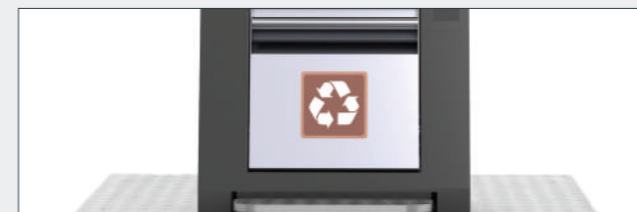

CUSTOMISATION –

Waste identification plates may be easily added. Each disposal column may be customised with stickers, logos, emblems and instructions for each fraction



FRONT PAPER ACCESS (WITHOUT DRAWER) –

- ▶ Standard dimensions: 485 x 162 mm
- ▶ XL dimensions: 854 x 166 mm

CLICK ON CERTAIN ITEMS
TO LEARN MORE.



EVOLUTION

DISPOSAL COLUMNS ▶

SOLIDITY AND DURABILITY

The Evolution disposal column is made of stainless steel. A finishing in stainless or hot-galvanised steel is available, treated through cataphoresis and painted. In both finishings, the disposal column is totally prepared to withstand any weather conditions. The disposal column's measurements make it fully accessible to all citizens, without taking up a lot of street space.

The disposal column may be customised with logos and waste instructions, facilitating citizen recycling.

The disposal column's simple and compact design makes it easy to dismantle in order to access all inside components. It consists of a professional door facilitating access to large producers (HORECA) and authorised staff, if the container needs to be handled. The container may be fitted with a sensor upon request, to detect the filling level and to optimise collection routes.

Thanks to its small number of parts, it is easy to dismantle and maintenance is simple and efficient.

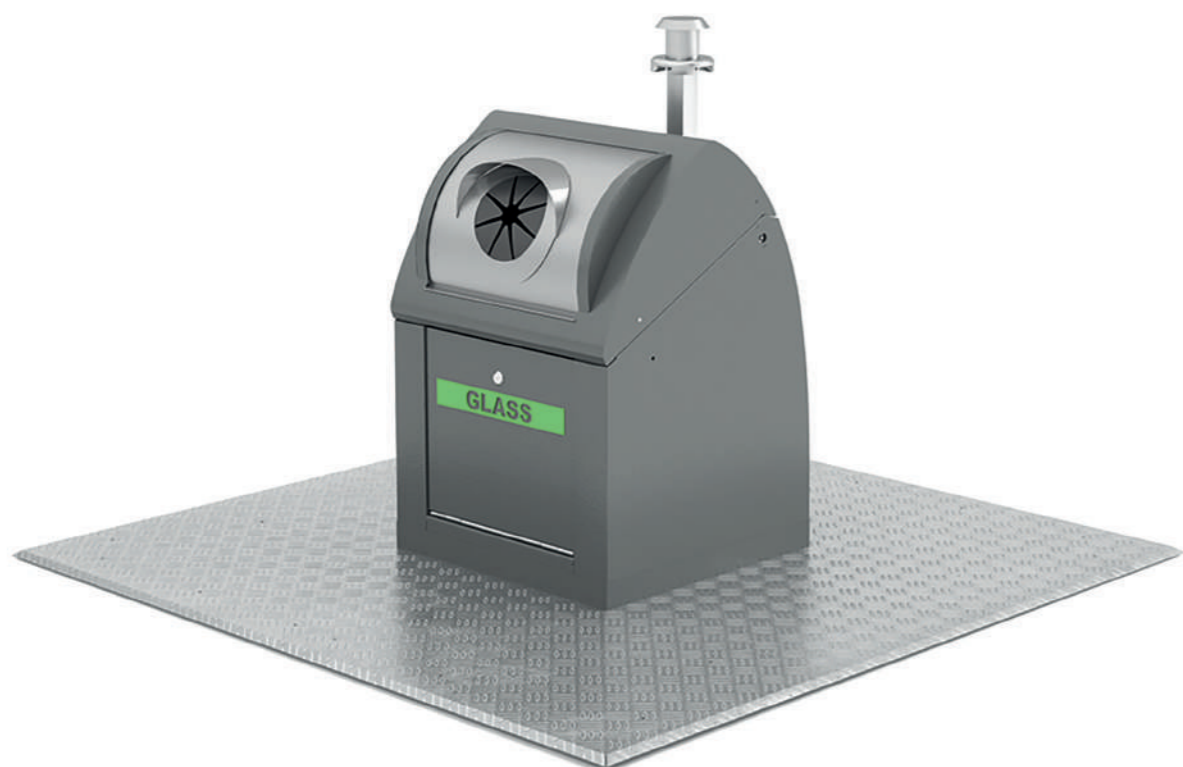

ACCESSORIES ▶



DRUM -

Single or double drum available.
Possible capacity:

- ▶ 80 L (entry window 460 x 390 mm)
- ▶ 100 L (entry window 560 x 390 mm)
- ▶ 120 L (entry window 660 x 390 mm)



CHECK VALVE -

For the recycling of paper and packaging. Fitted with an anti-splash rubber protector. Sizes available:

- ▶ 340 x 162 mm
- ▶ 440 x 162 mm
- ▶ 540 x 162 mm



SELECTIVE OPENING -

Selective opening to recycle glass or biowaste.
Available opening diameter 200 and 300 mm



DOUBLE DRUM -

To limit drum capacity and avoid citizen access to container-deposited waste. It may be fitted with an access control system

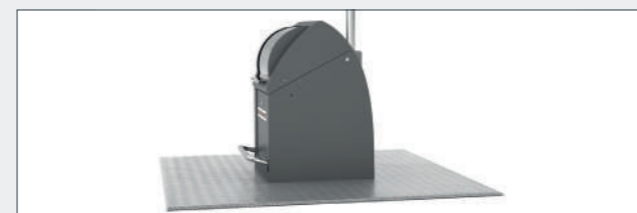

PEDAL -

Made of galvanised steel. Ergonomic pedal to facilitate effortless disposal column access



ACCESS CONTROL -

Card-operated control of user access, generating a log, frequency of use and amount of generated waste



CUSTOMISATION -

Each disposal column may be customised with logos, emblems and instructions for each fraction

CLICK ON CERTAIN ITEMS
TO LEARN MORE.



EUROPA

DISPOSAL COLUMNS ▶

DURABILITY AND EASY INSTALLATION

The Europe disposal column is made of high-density polyethylene. It has an inside structure made of galvanised steel and a drum manufactured in stainless steel, with 60 and 80 litre capacity. It has been designed with a textured finish to repel stickers or graffiti.

Each disposal column may be customised with different colours, depending on the type of waste recycled. It may also be customised at the access opening with an identification plate.

Thanks to its simplified design, it is easily dismantled and interchangeable.

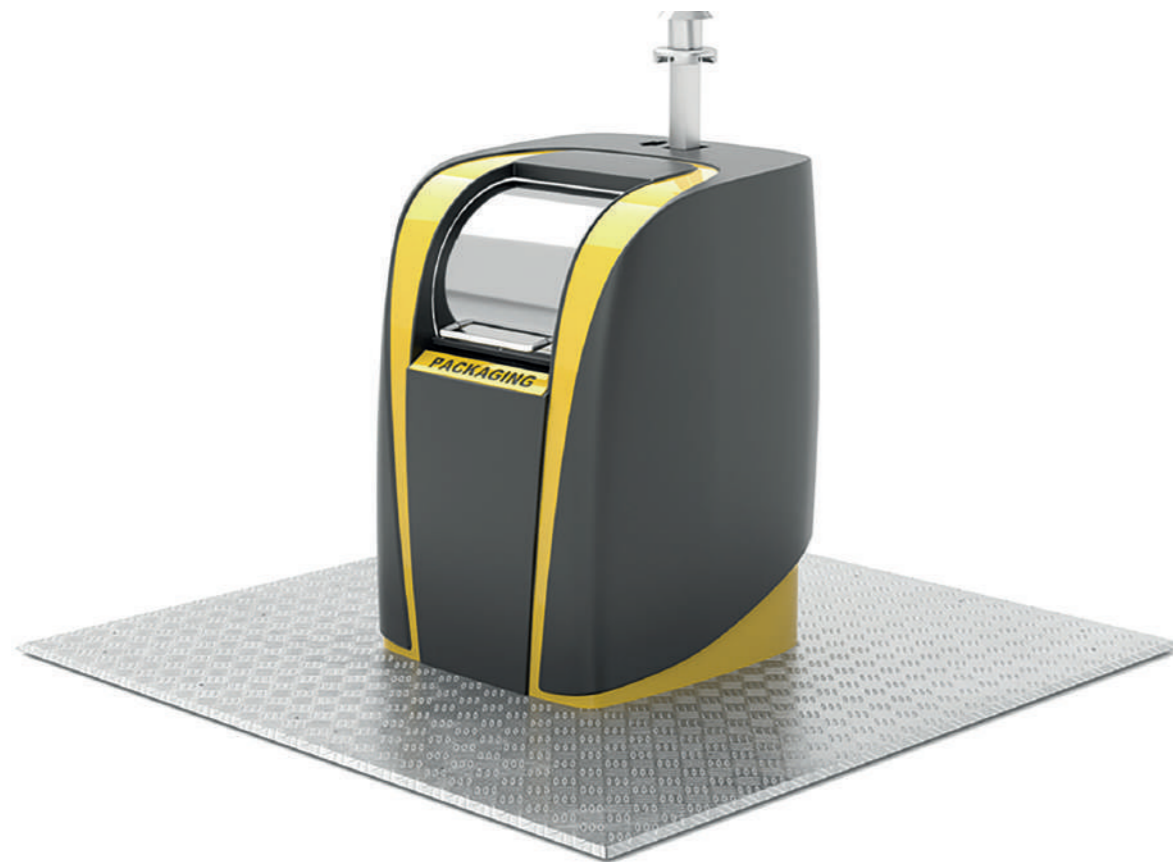

ACCESSORIES ▶



SINGLE DRUM -

Fitted with a counterweight system to help opening and closing of the door. Available capacity:

- ▶ 80 L (entry window 415 x 385 mm)



DOUBLE DRUM -

This allows drum capacity to be limited, avoiding citizen access to container-deposited waste. It may be fitted with an access control system



SELECTIVE OPENING -

Selective opening to recycle glass. Available opening diameter 200 mm



CHECK VALVE -

Used to recycle paper and packaging. Fitted with an anti-splash rubber protector



CUSTOMISATION -

Each disposal column may be differentiated by colour depending on the type of waste to recycle. The access opening may be customised with an identification plate

CLICK ON CERTAIN ITEMS
TO LEARN MORE.



MILENIUM

DISPOSAL COLUMNS ▶

RESISTANT AND EASILY CLEANED

The Milenium disposal column is made of high-density polyethylene. It has an internal structure made of galvanised steel and a drum manufactured in stainless steel, with capacity of 60 and 80 litres.

The disposal column may be customised with an identification plate in the access opening, depending on the type of waste to recycle.

Thanks to its simple design it is easily dismantled and exchangeable.



ACCESSORIES ▶



SINGLE DRUM -

Fitted with a counterweight system to help opening and closing of the door. Available capacity:

- ▶ 60 L with a restrictor (entry window 415 x 385 mm)
- ▶ 80 L (entry window 415 X 385 mm)



DOUBLE DRUM -

Selective opening to recycle glass or biowaste, fitted with an anti-splash rubber protector. Available opening diameters: 200 and 300 mm



SELECTIVE OPENING -

Selective opening to recycle glass or biowaste, fitted with an anti-splash rubber protector. Available opening diameters: 200 and 300 mm



CHECK VALVE -

Used to recycle paper and packaging. Fitted with an anti-splash rubber protector



CUSTOMISATION -

The access opening may be customised with an identification plate

CLICK ON CERTAIN ITEMS
TO LEARN MORE.



MINIM

DISPOSAL COLUMNS ▶

MINIMALISM AND OPTIMISATION

The Minim disposal column can be manufactured in stainless steel or galvanised steel with primer and epoxy paint. Galvanised steel offers three different finishes in three different shades of matt grey.

The simplicity of its design and ease of assembly and maintenance make it a functional and economic disposal column, without losing out on quality and resistance.

The disposal column is designed with different independent parts, which allows for easy assembly and maintenance and replacement of parts in case of damage.

The opening and closing system uses a hinged lid and a gas shock absorber. As a result, it closes smoothly, quietly and with no risk of entrapment for the user. It also has a protective rubber on the edge of the opening that guarantees a silent closing.

The disposal column can be customised with logos and waste instructions to make recycling easier for citizens.



ACCESSORIES ▶



STANDARD OPENING –

Available dimensions:

- ▶ 405 x 556 mm



PAPER OPENING –

Designed for paper recycling.

Available dimensions:

- ▶ 470 x 165 mm



GLASS OPENING –

Selective opening for glass recycling

Available diameter 200 mm



CIRCULAR OPENING –

Selective opening for the recycling of packaging

Available diameter 380 mm



CUSTOMISATION –

The entire surface of the disposal column can be customised with logos, emblems and recycling instructions using vinyl, polycarbonate or other materials

LITTER BINS

▶ OMEGA SERIES

▶ AGORA SERIES

▶ EUROPA SERIES

▶ MILENIUM SERIES

▶ DIN

▶ BARCELONA SERIES

▶ GOYA

▶ CLASSIC

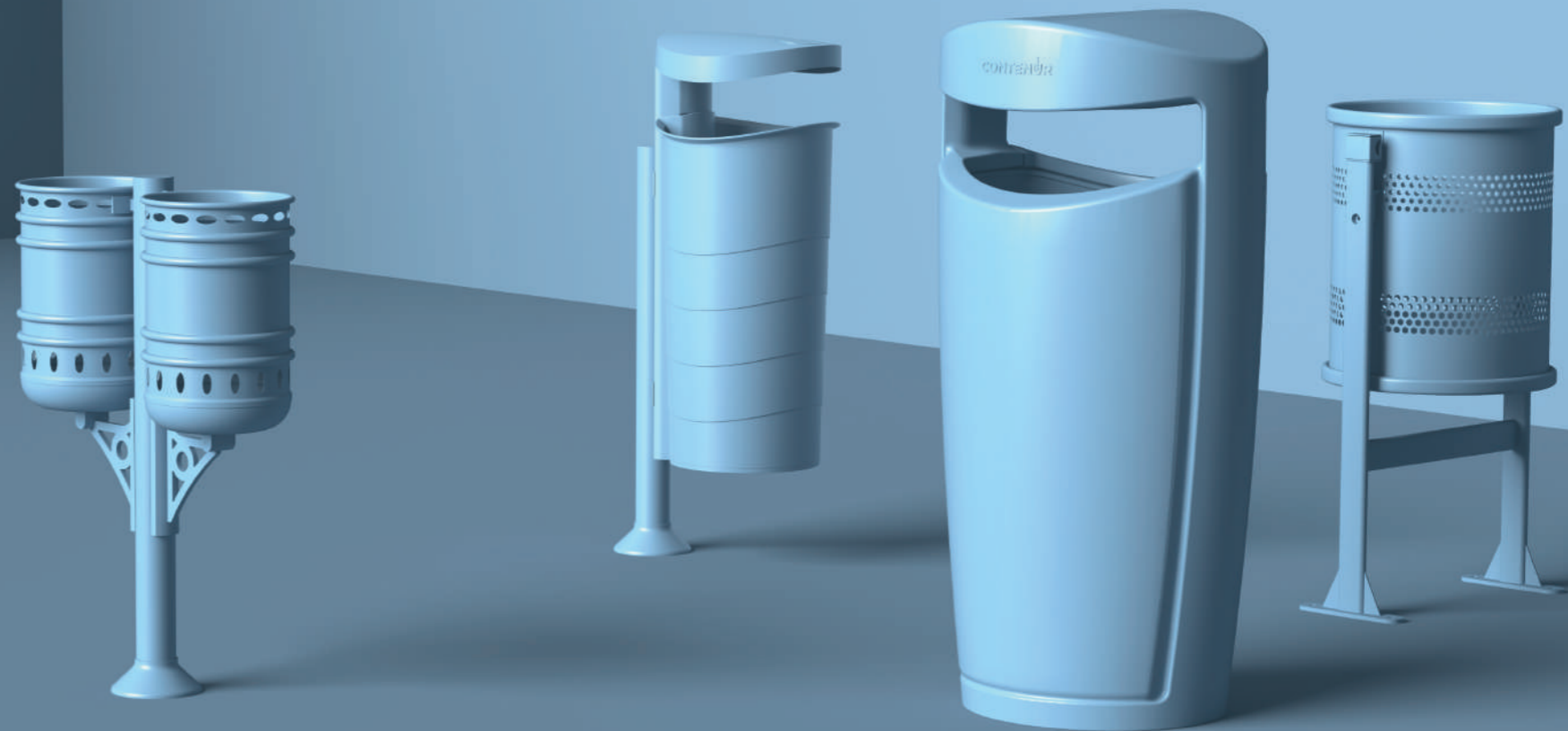

CLICK ON CERTAIN ITEMS
TO LEARN MORE.



LITTER BINS

Fully integrated into the landscape

CONTENUR's litter bins are conceived to become a part of a city's landscape. They are designed to ensure a more efficient and speedy collection of waste and cleaning tasks, and are highly resistant to external factors.

Manufactured with the highest quality standards in polyethylene, steel or cast aluminium following strict quality regulations. They provide functional and design solutions, for the selective collection of different types of waste, paper, cardboard, glass, packaging, other waste, etc..

Designed for comfortable and easy use. All **CONTENUR** litter bins are manufactured with the least number of parts to facilitate assembly.

The range of **CONTENUR** litter bins has a wide range of designs, from the Goya or Classic series (functional and resistant) to the most modern, with a neutral and versatile design, such as OMEGA or Milenium litter bins.



INTEGRATED INTO
THE CITY'S LANDSCAPE



USER-FRIENDLY



WIDE RANGE



CLICK ON CERTAIN ITEMS
TO LEARN MORE.



LITTER BINS



DESIGN

CONTENUR's litter bins are conceived for integration into each city's landscape.



USER-FRIENDLY

Designed to ensure comfortable and simple use.



ERGONOMICS

CONTENUR's range of litter bins has a wide, ergonomic front area to facilitate emptying.



CUSTOMISATION

All litter bins may be customised with emblems, logos, etc. plated, stencilled or with a sticker.



EFFICIENT MAINTENANCE

A streamlined design for less maintenance.



ANTI-RUST TREATMENT

All metal components are treated through a cathaphoresis or hot-galvanising process to avoid any corrosion.

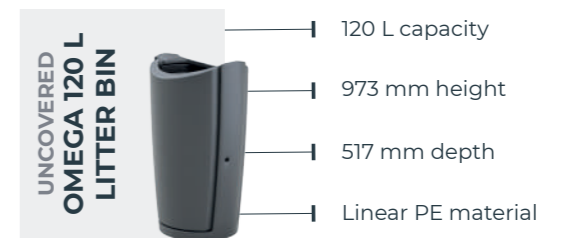
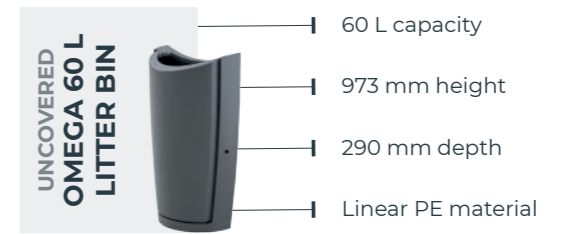
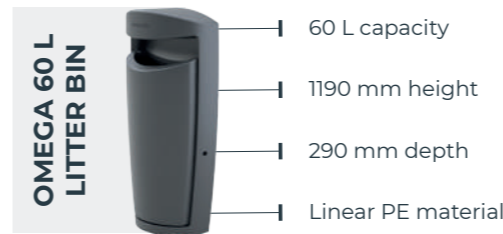
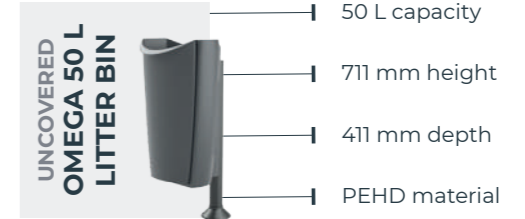

Model	Capacity	Basket capacity	Total height	Maximum width	Total depth	Material
OMEGA 50 L Litter bin	50 L	50 L	875 mm	450 mm	411 mm	Injected polyethylene
OMEGA 50 L Litter bin Uncovered	50 L	50 L	711 mm	450 mm	411 mm	Injected polyethylene
OMEGA 60 L Litter bin	60 L	60 L	1190 mm	590 mm	290 mm	Linear polyethylene
OMEGA 60 L Litter bin Uncovered	60 L	60 L	973 mm	590 mm	290 mm	Linear polyethylene
OMEGA 120 L Litter bin	120 L	120 L	1190 mm	590 mm	517 mm	Linear polyethylene
OMEGA 120 L Litter bin Uncovered	120 L	120 L	973 mm	590 mm	517 mm	Linear polyethylene

CLICK ON CERTAIN ITEMS
TO LEARN MORE.

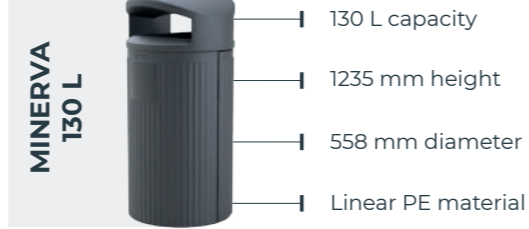
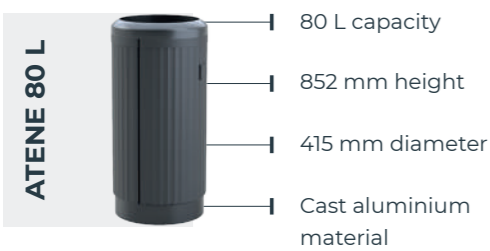
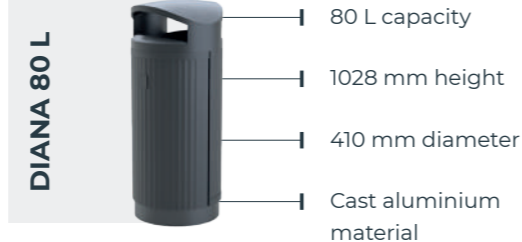
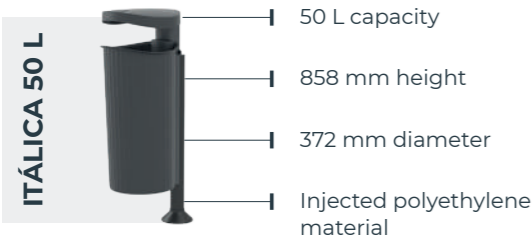

Model	Capacity	Basket capacity	Total height	Maximum diameter	Material
Itálica 50 L	50 L	50 L	858 mm	372 mm	Injected polyethylene
Diana 80 L	80 L	65 L	1028 mm	410 mm	Cast aluminium
Atenea 80 L	80 L	65 L	852 mm	415 mm	Cast aluminium
Minerva 130 L	130 L	120 L	1235 mm	558 mm	Linear polyethylene

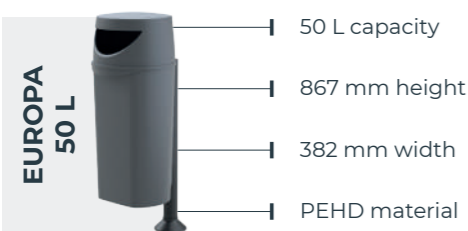

Model	Capacity	Basket capacity	Total height	Maximum width	Material
Europa 50 L	50 L	50 L	867 mm	382 mm	Injected polyethylene
Europa 130 L	130 L	120 L	1165 mm	575 mm	Linear polyethylene

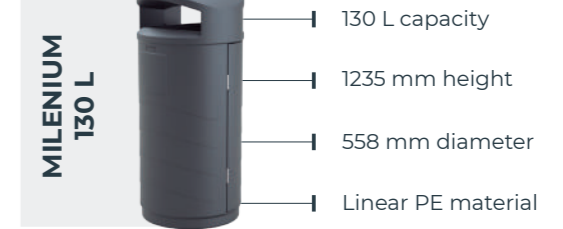
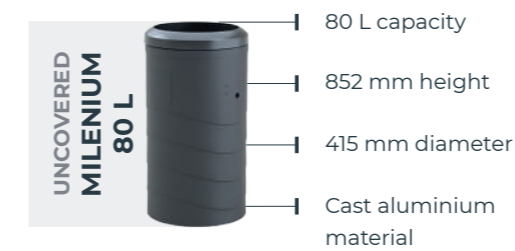
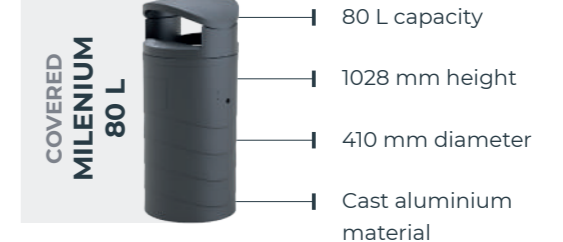
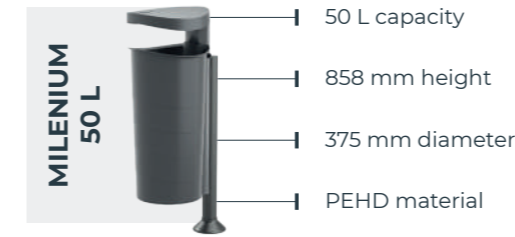

Model	Capacity	Basket capacity	Total height	Maximum diameter	Material
Milenium 50 L	50 L	50 L	858 mm	375 mm	Injected polyethylene
Milenium 80 L Covered	80 L	65 L	1028 mm	410 mm	Cast aluminium
Milenium 80 L Uncovered	80 L	65 L	852 mm	415 mm	Cast aluminium
MILENIUM 130 L	130 L	120 L	1235 mm	558 mm	Linear polyethylene

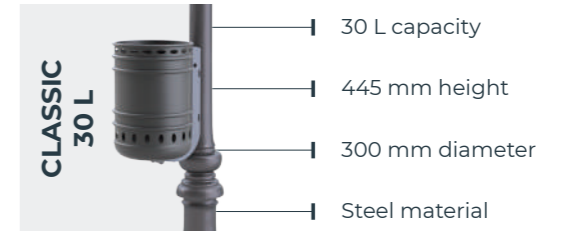
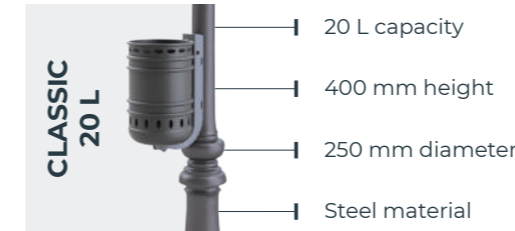

Model	Capacity	Total height	Total diameter	Material
Classic 20 L	20 L	400 mm	250 mm	Steel
Classic 30 L	30 L	445 mm	300 mm	Steel

CLICK ON CERTAIN ITEMS
TO LEARN MORE.

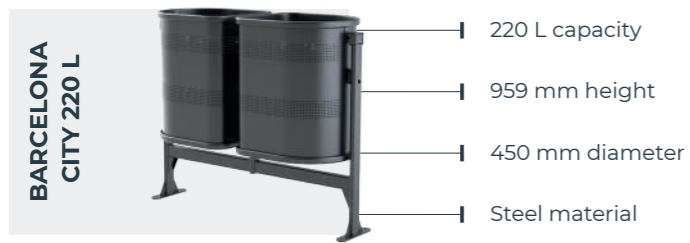
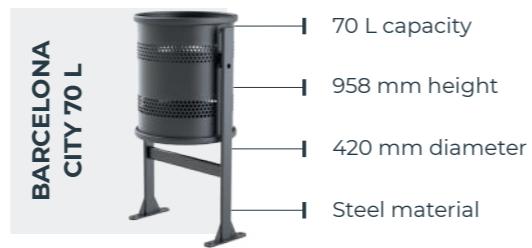
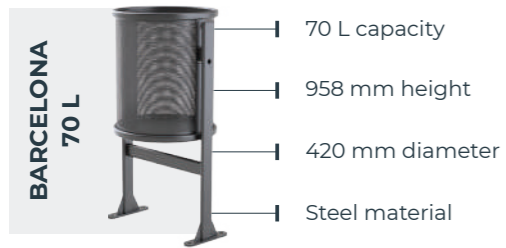
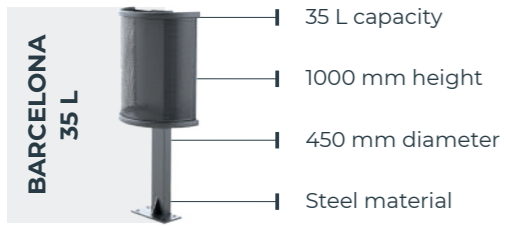

Model	Capacity	Total height	Total width	Basket diameter	Material
Barcelona 35 L	35 L	1000 mm	228 mm	450 mm	Steel
Barcelona 50 L	50 L	958 mm	462 mm	360 mm	Steel
Barcelona 70 L	70 L	958 mm	517 mm	420 mm	Steel
Barcelona City 70 L	70 L	958 mm	517 mm	420 mm	Steel
Barcelona City 220 L	220 L	959 mm	512 mm	450 mm	Steel

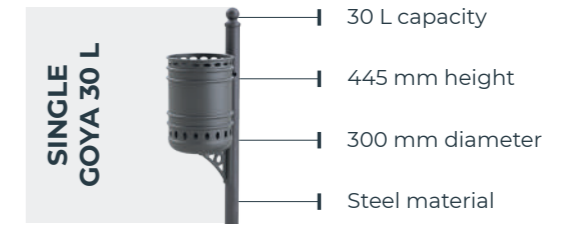
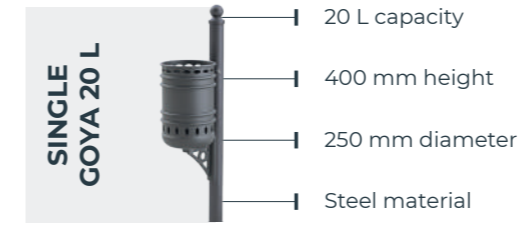

Model	Capacity	Basket height	Basket diameter	Material
Single Goya 20 L	20 L	400 mm	250 mm	Steel
Single Goya 30 L	30 L	445 mm	300 mm	Steel
Double Goya 40 L	40 L	400 mm	250 mm	Steel
Double Goya 60 L	60 L	445 mm	300 mm	Steel

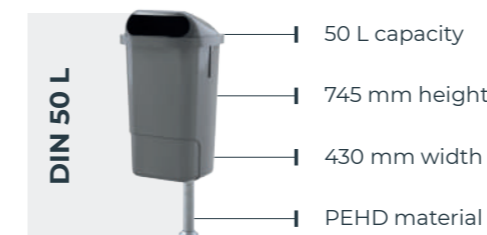

Model	Capacity	Total height	Depth	Maximum width	Material
Din	50 L	745 mm	340 mm	430 mm	Injected polyethylene

CLICK ON CERTAIN ITEMS
TO LEARN MORE.



OMEGA

LITTER BINS ▶

AESTHETICS, EFFICIENCY AND CIRCULARITY

Our range of **OMEGA** litter bins is available in 50, 60 and 120 litre sizes. Their streamlined design, with soft and simple lines, has been conceived for their location in cities with a modern and renovated image.

All OMEGA litter bins are 100% recoverable at the end of their useful life. The entire range may be manufactured with up to 100% of recycled material. Manufactured using injected high-density polyethylene or with rotomoulding in linear polyethylene.

Our family of OMEGA litter bins has been designed with a textured finish to avoid the adherence of stickers or graffiti.

The feeding area in all litter bins is placed at a maximum height of 900 mm for greater accessibility. All litter bins in the OMEGA family meet Accessibility Standard - UNE EN 170001.



Model	Capacity	Basket Capacity	Total height	Maximum width	Total depth	Material
OMEGA 50 L Litter bin	50 L	50 L	875 mm	450 mm	411 mm	Injected polyethylene
OMEGA 50 L Litter bin Uncovered	50 L	50 L	711 mm	450 mm	411 mm	Injected polyethylene
OMEGA 60 L Litter bin	60 L	60 L	1190 mm	590 mm	290 mm	Linear polyethylene
OMEGA 60 L Litter bin Uncovered	60 L	60 L	973 mm	590 mm	290 mm	Linear polyethylene
OMEGA 120 L Litter bin	120 L	120 L	1190 mm	590 mm	517 mm	Linear polyethylene
OMEGA 120 L Litter bin Uncovered	120 L	120 L	973 mm	590 mm	517 mm	Linear polyethylene



CLICK ON CERTAIN ITEMS
TO LEARN MORE.



OMEGA 50 L

LITTER BIN ▶



ACCESSORIES ▶



ASHTRAY -

This accessory is only available to each Model's standard version. Located at the centre of the litter bin lid, it allows cigarette butts to be put out and discarded inside



PLASTIC BAG DISPENSER -

Litter bins may come with a plastic bag dispenser for dog excrement. Located on the side of the litter bin. Capacity for 50 bags, useful size: 65 x 60 mm



ELECTRONIC CHIP -

Space available in the litter bin lid for the hosting of chips. It facilitates product identification and tracking



UNCOVERED OMEGA 50 L LITTER BIN -

The OMEGA 50 L litter bin may be provided without a top lid



STANDARD CUSTOMISATION -

The body of the litter bin may be customised through a plate, maximum size available: 230 x 230 mm. If screen printed or thermal printed, maximum size 150 x 150 mm



CUSTOMISED LID -

The litter bin lid may be customised with Braille marking and relief, maximum size: 77 x 35 mm



PREMIUM CUSTOMISATION -

Upon request, customisation may be integrated into the body (relief), maximum size available: 230 x 230 mm

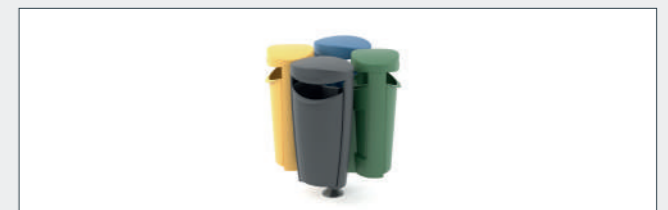

ISLAND OPTION -

A litter bin island allows users to separate the waste at source and facilitates its selective collection. Specifically conceived for busy urban surroundings

CLICK ON CERTAIN ITEMS
TO LEARN MORE.



OMEGA 60 L

LITTER BIN ▶



ACCESSORIES ▶



ASHTRAY -

This accessory is only available to each Model's standard version. Located at the centre of the litter bin lid, it allows cigarette butts to be put out and discarded inside



PLASTIC BAG DISPENSER -

Litter bins may come with a plastic bag dispenser for dog excrement. Located on the side of the litter bin. Capacity for 50 bags, useful size: 65 x 60 mm

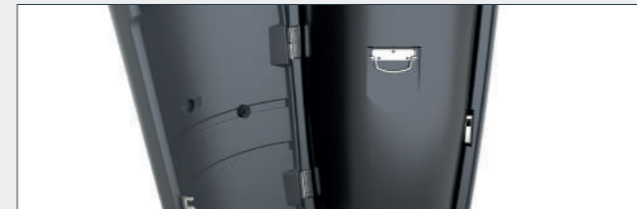

ELECTRONIC CHIP -

Space available in the litter bin lid for the hosting of chips. It facilitates product identification and tracking



UNCOVERED OMEGA 60 L LITTER BIN -

The OMEGA 60 L litter bin may be provided without a top lid

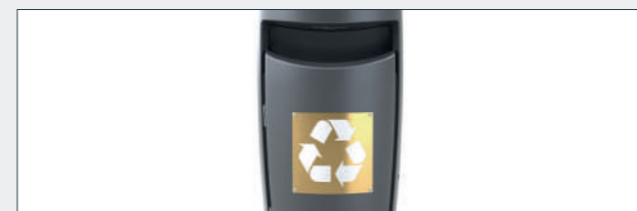

STANDARD CUSTOMISATION -

The body of the litter bin may be customised through thermal printing or a plate, maximum size available: 300 x 300 mm



CUSTOMISED LID -

The litter bin lid may be customised with Braille marking and relief, maximum size: 80 x 36 mm



PREMIUM CUSTOMISATION -

The body of the litter bin may be customised with an integrated sticker or relief, maximum size: 300 x 300 mm

CLICK ON CERTAIN ITEMS
TO LEARN MORE.



OMEGA 120 L

LITTER BIN ▶



ACCESSORIES ▶



ASHTRAY -

This accessory is only available to each Model's standard version. Located at the centre of the litter bin lid, it allows cigarette butts to be put out and discarded inside



PLASTIC BAG DISPENSER -

Litter bins may come with a plastic bag dispenser for dog excrement. Located on the side of the litter bin. Capacity for 50 bags, useful size: 65 x 60 mm



ELECTRONIC CHIP -

Space available in the litter bin lid for the hosting of chips. It facilitates product identification and tracking



BICOMPARTMENT OPTION -

A bicompartment basket for the selection collection of different types of waste: paper and cardboard, glass, packaging, etc



UNCOVERED OMEGA 120 L LITTER BIN -

The OMEGA 120 L litter bin may be manufactured without a top lid



STANDARD CUSTOMISATION -

The body of the litter bin may be customised with a plate, maximum size available: 300 x 300 mm



PREMIUM CUSTOMISATION -

The body of the litter bin may be customised with an integrated sticker or relief, maximum size: 300 x 300 mm



CUSTOMISED LID -

The litter bin lid may be customised with Braille marking and relief, maximum size: 80 x 36 mm

CLICK ON CERTAIN ITEMS
TO LEARN MORE.



AGORA

LITTER BINS ▶

The litter bins in **CONTENUR's** Agora series are designed with vertical ribbing for unit reinforcement and to discourage the posting of signs and stickers.

All litter bins have a triangular-key operated lock, for comfortable and easy handling.

All 80 L and 130 L capacity litter bins have a support base integrated into the body and mounted on the pavement with six universal anchor brackets, 12 mm wide, whereas 50 L litter bins include a mounting system made of highly resistant technical plastic.



ACCESSORIES ▶



BASKET -

A basket with 50, 65 and 120 L capacity, fitted with a handle to facilitate litter bin handling during emptying



BICOMPARTMENT OPTION -

Bicompartiment hoop or basket for the selective collection of different types of waste: paper and cardboard, glass, packaging, etc.



ASHTRAY -

An outside ashtray with an avant-garde design, made of galvanised or stainless steel

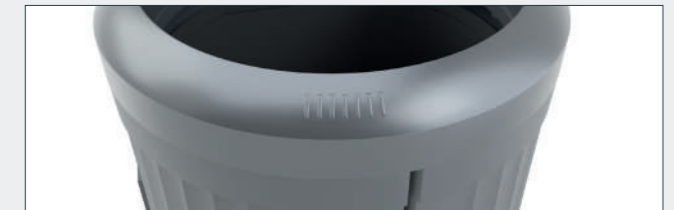

CIGARETTE EXTINGUISHERS -

A grooved butt extinguishing plate integrated into the body of the litter bin, for the putting out of cigarettes



ISLAND OPTION -

A litter bin island allows users to separate the waste at source and facilitates its selective collection. Specifically conceived for busy urban surroundings



CUSTOMISATION -

Plated in the body, sizes available:

- ▶ Diana 80 L and Atenea 80 L: 62 x 62 mm
- ▶ Minerva 130 L: 200 x 200 mm
- ▶ Itálica 50 L: with an embossing insert in the lid, max. diameter of 79 mm

Model	Capacity	Basket capacity	Total height	Maximum diameter	Material
Itálica 50 L	50 L	50 L	858 mm	372 mm	Injected polyethylene
Diana 80 L	80 L	65 L	1028 mm	410 mm	Cast aluminium
Atenea 80 L	80 L	65 L	852 mm	415 mm	Cast aluminium
Minerva 130 L	130 L	120 L	1235 mm	558 mm	Linear polyethylene

CLICK ON CERTAIN ITEMS
TO LEARN MORE.



EUROPA

LITTER BINS ▶

The litter bins included in **CONTENUR's** Europa series are designed with a smooth surface area for easy cleaning. Upon request, they may be manufactured in a wide range of colours. Manufactured through linear polyethylene rotomoulding or with injected high-density polyethylene.

All Europa litter bins are locked with a triangular key, for comfortable and easy handling.

Each Europa 50 L litter bin includes a mounting system made of highly resistant engineered plastic, whereas Europa 130 L litter bins have a support base integrated into the body and mounted on the pavement with six universal bracket anchors, 12 mm wide.



ACCESSORIES ▶



BASKET –

A basket with 50 and 120 L capacity, fitted with a handle to facilitate litter bin handling during emptying



BICOMPARTMENT OPTION –

Bicompartment hoop or basket for the selective collection of different types of waste: paper and cardboard, glass, packaging, etc.

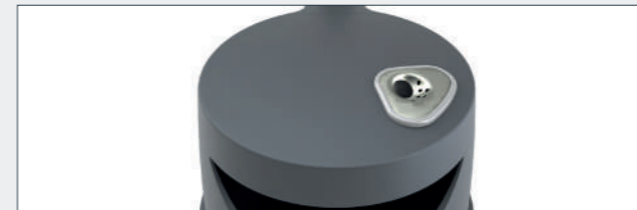

ASHTRAY –

Outside ashtray made of galvanised or stainless steel



CUSTOMISATION –

Europa 50 L litter bin: thermally printed or with a sticker on the body, maximum size available: 200 x 180 mm

Europa 130 L litter bin: plated on the body, maximum size available: 200 x 200 mm



Model	Capacity	Basket capacity	Total height	Maximum width	Material
Europa 50 L	50 L	50 L	867 mm	382 mm	Injected polyethylene
Europa 130 L	130 L	120 L	1165 mm	575 mm	Linear polyethylene

CLICK ON CERTAIN ITEMS
TO LEARN MORE.



MILENIUM

LITTER BINS ▶

The litter bins included in **CONTENUR's** Milenium series are designed with smooth surface areas for easier cleaning. Manufactured in cast aluminium, through linear polyethylene rotomoulding or injected high-density polyethylene.

All 80 L and 130 L capacity litter bins have a support base integrated into the body and mounted on the pavement with six universal anchor brackets, 12 mm wide, whereas 50 L litter bins include a mounting system made of highly resistant engineered plastic.



ACCESSORIES ▶



BASKET -

A basket with 50, 65 and 120 L capacity, fitted with a handle to facilitate litter bin handling during emptying

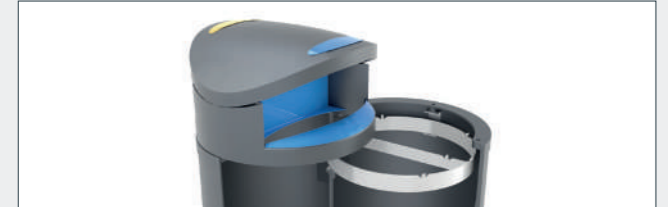

BICOMPARTMENT OPTION -

Bicompartiment hoop or basket for the selective collection of different types of waste: paper and cardboard, glass, packaging, etc.



ASHTRAY -

Outside ashtray made of galvanised or stainless steel

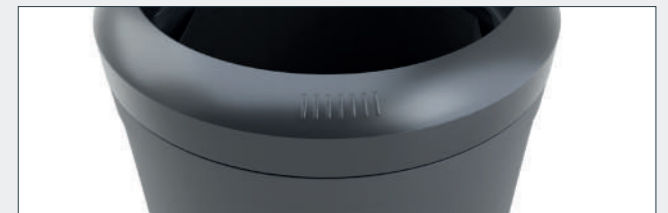

CIGARETTE EXTINGUISHERS -

A grooved butt extinguishing plate integrated into the body of the litter bin, for the putting out of cigarettes



CUSTOMISATION -

Through an embossing insert in the lid:

- ▶ Milenium 50 L, max. diameter 79 mm

Plated on the body:

- ▶ Covered Milenium 80 L, Open Milenium 80 L, max. size 125 x 125 mm
- ▶ Milenium 130 L, max. size 200 x 200 mm

Model	Capacity	Basket capacity	Total height	Maximum diameter	Material
Milenium 50 L	50 L	50 L	858 mm	375 mm	Injected polyethylene
Milenium 80 L Covered	80 L	65 L	1028 mm	410 mm	Cast aluminium
Milenium 80 L Uncovered	80 L	65 L	852 mm	415 mm	Cast aluminium
Milenium 130 L	130 L	120 L	1235 mm	558 mm	Linear polyethylene

CLICK ON CERTAIN ITEMS
TO LEARN MORE.



DIN

LITTER BINS ▶

DIN litter bins are made of injected high-density polyethylene. The basket is designed with a smooth surface for easier cleaning, providing customisation potential in the form of emblems, logos, etc. through a thermal printing process.

The litter bin's locking system is at the back, and is fitted with a standard key for easy waste removal without having to take the lid off. The mounting system is made of highly resistant engineered plastic under standard DIN 30713 and the litter bin support of is made of plated steel with anti-rust paint.



ACCESSORIES ▶



LID -

Lid with a front opening for loading, size available 310 x 90 mm



BODY -

50 L capacity body, made of injected high-density polyethylene



CUSTOMISATION -

Thermally printed or with a sticker on the body, max. size available: 200 x 200 mm

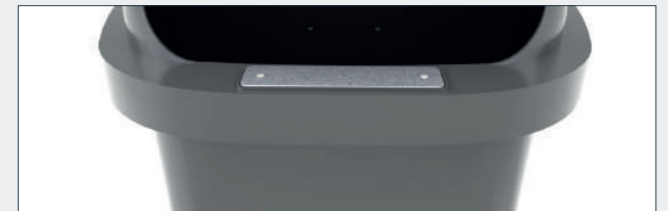

CIGARETTE EXTINGUISHERS -

A grooved butt extinguishing plate integrated into the body of the litter bin, for putting out cigarettes



AVAILABLE COLOURS -

Upon request, this litter bin may be manufactured in many different colours



ISLAND OPTION -

A litter bin island allows users to separate the waste at source and facilitates its selective collection. Specifically conceived for busy urban surroundings

Model	Capacity	Total height	Depth	Maximum width	Material
Din	50 L	745 mm	340 mm	430 mm	Injected polyethylene

CLICK ON CERTAIN ITEMS
TO LEARN MORE.



BARCELONA

LITTER BINS ▶

The litter bins included in **CONTENUR's** Barcelona series are made of perforated steel plate, 1.5 mm thick. They are painted with polyester dust for the outdoors, to ensure that they are long-lasting and resistant to external factors. Standard colour: oxiron grey.

All these litter bins have a side-operated locking system, which allows the basket to tip during emptying, for comfortable and easy handling.

A pavement mounting system that uses 4 universal anchor brackets, 12 mm wide.



ACCESSORIES ▶



BASKET –

A basket with 35, 50, 70 and 220 L capacity, fitted with a side-operated lock to facilitate litter bin handling during emptying



ASHTRAY –

Outside ashtray available for Barcelona City 220 L litter bins, made of galvanised steel and painted oxiron grey



CUSTOMISATION –

** Only available for Barcelona City 70 L litter bins*

Stencilled basket

Model	Capacity	Total height	Total width	Basket diameter	Material
Barcelona 35 L	35 L	1000 mm	228 mm	450 mm	Steel
Barcelona 50 L	50 L	958 mm	462 mm	360 mm	Steel
Barcelona 70 L	70 L	958 mm	517 mm	420 mm	Steel
Barcelona City 70 L	70 L	958 mm	517 mm	420 mm	Steel
Barcelona City 220 L	220 L	959 mm	512 mm	450 mm	Steel

CLICK ON CERTAIN ITEMS
TO LEARN MORE.



GOYA

LITTER BINS ▶

All Goya litter bins are made of galvanised steel and designed with a smooth surface for easier cleaning. The mounting support has a basic design to facilitate an exchange of varying capacity baskets.

These litter bins have a tiltable system operated through a side lock, to facilitate handling of the litter bin during emptying.

Treated with polyester dust for the outdoors. Standard colour: oxiron grey.



Model	Capacity	Basket height	Basket diameter	Material
Single Goya 20 L	20 L	400 mm	250 mm	Steel
Single Goya 30 L	30 L	445 mm	300 mm	Steel
Double Goya 40 L	40 L	400 mm	250 mm	Steel
Double Goya 60 L	60 L	445 mm	300 mm	Steel

CLASSIC

LITTER BINS ▶

The Classic litter bin is made of galvanised steel and is designed with a smooth surface for easier cleaning. Its 20 or 30 litre capacity basket is made of steel plate, 1.2 mm thick, with an upper reinforcing rim.

The supporting base is fitted with a side-operated lock to facilitate litter bin handling during emptying.

Painted in dust polyester for the outdoors. Standard colour: oxiron grey.



Model	Capacity	Basket height	Total diameter	Material
Classic 20 L	20 L	400 mm	250 mm	Steel
Classic 30 L	30 L	445 mm	300 mm	Steel



CONTENÜR

CLICK ON CERTAIN ITEMS
TO LEARN MORE.



SUSTAINABILITY CIRCLE® PROJECT

Creating a more sustainable future

CIRCLE® is the concept that encompasses and defines **CONTENUR's** strategy, positioning, working method, obligations and developments in environmental sustainability matters, together with all components referred to in European Commission recommendations on topics and specific steps taken in the field of environmental sustainability and plastic recycling.

CIRCLE® is based on 4 concepts: OCS Certifications, Ecodesign, Energy Efficiency, and End-of-Life Product Recycling.

OCS ▶

Operation Clean Sweep®, a global initiative in the plastic industry to reduce potential losses of pellets (primary microplastics), in the form of chippings, scales or powdered resin, into the environment.

Our OCS certification recognises that **CONTENUR**, voluntarily, is actively committed to reducing this environmental waste by implementing a strict action plan.

Ecodesign ▶

Ecodesign involves identifying, as soon as a product/ service is conceived, any environmental impact that may arise in each stage of a product's life cycle, in order to try and reduce it to a minimum, without affecting its quality and benefits.

Our Ecodesign certificate proves that **CONTENUR** has adopted a management system to identify, control and continuously improve the environmental side of its products and/or services, informing our clients about any products that have included design-based environmental improvements, in accordance with standard UNE-EN ISO 14006.

Energy Efficiency ▶

CONTENUR only uses renewable energy sources in order to reduce CO2 emissions (*further information and targets available in our CSR report 2020 on our website*).

An energy efficiency management programme is in place to protect the environment, to reduce the level of energy used and to promote responsible consumer use.

End-of-Life Product Recycling ▶

The recycling process seeks to convert waste into resources or raw materials for subsequent use in new products.

The starting point are end-of-life materials provided by our clients, along with plastic for other use that is processed through recycling entities.

We have been working and developing formulae for 5 years now, in order to use end-of-life materials as new commodities with added antioxidants, UV protectors and buffers.

CIRCLE®

WHAT IS IT AND HOW DOES IT WORK?



<p>1. Strategic agreements with local councils to start up the Circle® project in their cities.</p>	<p>5. Laboratory control of raw materials obtained. Process traceability, audited by an external entity. Trials and quality testing of recovered materials.</p>	<p>8. New containers are ready for delivery.</p>
<p>2. Collection of old containers.</p>	<p>6. New container manufacturing, meeting the highest quality standards.</p> <ul style="list-style-type: none"> • ISO 14,006 Ecodesign • ISO 50,001 100% Renewable Energy • OCS Certification Minor pellet losses 	<p>9. Promoted recycling. Extended useful life of our products. We encourage responsible citizen conduct.</p>
<p>3. Container transfer to a shredding facility.</p>	<p>7. Completion of quality control tests on already manufactured products, to guarantee Circle® project feasibility.</p>	<p>10. Maintenance. Adequate container maintenance helps extend the product's useful life.</p>
<p>4. Recovery of raw materials. Treatment for cleaning, separation and shredding.</p>		



**www.
contenur.
com/en**

MK26CORP.CAT.ENEXP.V1