





**CONTENUR**  
Torneros 3  
Pol. In. Los Ángeles  
28906 Getafe  
Madrid, Spain

[www.contenur.com/en](http://www.contenur.com/en)

# PRODUCT **CATALOGUE**

CLICK ON CERTAIN ITEMS  
TO LEARN MORE.



# CRANE-LIFT

## RANGE ▶

### Perfect for selective collection

CONTENUR's crane-lift range are manufactured through rotomoulding, with high-density linear polyethylene dyed in the mass and stabilised to fight the combined action of water and UV rays, extending their useful life and generating a highly resistant product to atmospheric agents.

These containers are manufactured under the highest international standards, and hold strict quality and product certifications.

Conceived to easily fit into the city's landscape, offering specific solutions for each type of waste. Available in a wide range of colours, with a full set of accessories to resolve any incident that may arise in each city's waste collection. Different lifting systems available: regular hook, double hook or Kinshofer.

Thanks to its manufacturing system, materials and design, little maintenance is required.



INTEGRATED INTO  
THE CITY LANDSCAPE



SUSTAINABILITY



EASILY EMPTIED

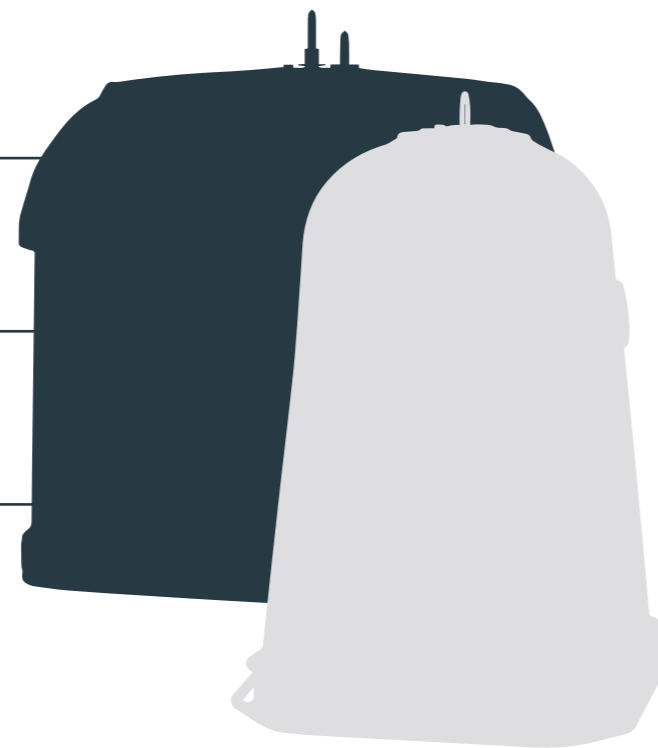

# CRANE-LIFT

## RANGE ▶



### MANUFACTURING

Manufactured using a rotomoulding system with high-density linear polyethylene, extending its useful life.



### LIFTING SYSTEM

Anti-rust metal lifting system. Available for different systems: regular hook, double hook and Kinshofer.



### DESIGN

Conceived for full integration into city and rural areas, offering specific solutions for each type of waste.



### CUSTOMISATION

Crane-Lift – Bilateral-Loading containers may be customised with emblems, logos, etc., by placing a sticker or adhesive vinyl.



### CERTIFICATION

All Crane-Lift – Bilateral-Loading containers are designed and manufactured further to EN-13071 quality standards.



### EFFICIENT MAINTENANCE

Crane-Lift – Bilateral-Loading containers require little maintenance thanks to their manufacturing system, materials and design. Their small number of parts and components ensure efficient maintenance.

Model	Capacity	Unladen Weight	Maximum Load	Total Height	Opening Height	Lifting system
<b>360IGLOO</b>	3000 L	150 Kg	1200 Kg	1475 mm	1195 mm	Double hook / Kinshofer / F-90
<b>OVAL Igloo</b>	3000 L	140 Kg	1200 Kg	1600 mm	1190 mm 1250 mm	Double hook / Kinshofer
<b>OPTIK Igloo</b>	2000 L 3000 L 4000 L	207 Kg 246 Kg 285 Kg	800 Kg 1200 Kg 1600 Kg	1889 mm	1200 mm 1500 mm	Regular hook / Double hook / Kinshofer
<b>2 Side System Igloo</b>	2000 L 2800 L 3600 L	130 Kg 161 Kg 179 Kg	800 Kg 1120 Kg 1440 Kg	1600 mm	1180 mm	Double hook / Kinshofer
<b>Circular Igloo</b>	2500 L 3000 L	90 Kg 102 Kg	625 Kg 750 Kg	1700 mm	1400 mm 1420 mm	Double hook / Kinshofer
<b>Rectangular Igloo</b>	2500 L	120 Kg	625 Kg	1827 mm	1400 mm	Double hook / Kinshofer
<b>Agora Igloo</b>	2700 L	180 Kg	1080 Kg	1665 mm	1357 mm	Double hook / Kinshofer
<b>3200 Igloo</b>	3200 L	213 Kg	1280 Kg	1727 mm	1314 mm	Double hook / Kinshofer
<b>Cite Igloo</b>	2200 L	140 Kg	880 Kg	1854 mm	1200 mm 1463 mm	Double hook / Kinshofer
<b>Metallic Igloo</b>	3000 L	268 Kg	750 Kg	1620 mm	1300 mm	Double hook / Kinshofer

CLICK ON CERTAIN ITEMS  
TO LEARN MORE.



**360IGLOO**



- Double hook / Kinshofer / F-90
- 3000 L capacity
- 1200 Kg nominal load
- 1195 mm Opening Height

**OVAL IGLOO**



- Double hook / Kinshofer
- 3000 L capacity
- 1200 Kg nominal load
- 1190 - 1250 mm Opening Height

**OPTIK IGLOO 2000**



- Regular hook / Double hook / Kinshofer
- 2000 L capacity
- 800 Kg nominal load
- 1200 - 1500 mm Opening Height

**2 SIDE SYSTEM IGLOO- 2000 L**



- Double hook / Kinshofer
- 2000 L capacity
- 800 Kg nominal load
- 1180 mm Opening Height

**OPTIK IGLOO 3000**



- Regular hook / Double hook / Kinshofer
- Capacidad 3000 L
- 1200 Kg nominal load
- 1200 - 1500 mm Opening height

**2 SIDE SYSTEM IGLOO- 2800 L**



- Double hook / Kinshofer
- 2800 L capacity
- 1120 Kg nominal load
- 1180 mm Opening Height

**OPTIK IGLOO 4000**



- Regular hook / Double hook / Kinshofer
- 4000 L capacity
- 1600 Kg nominal load
- 1200 - 1500 mm Opening height

**2 SIDE SYSTEM IGLOO- 3600 L**



- Double hook / Kinshofer
- 3600 L capacity
- 1440 Kg nominal load
- 1180 mm Opening Height

# CRANE-LIFT RANGE ▶

**CIRCULAR IGLOO**



- Double hook / Kinshofer
- 2500 L capacity
- 625 Kg nominal load
- 1400 mm Opening Height

**RECTANGULAR IGLOO**

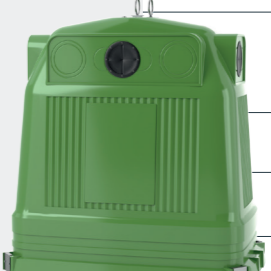

- Double hook / Kinshofer
- 2500 L capacity
- 625 Kg nominal load
- 1400 mm Opening Height

**AGORA IGLOO**



- Double hook / Kinshofer
- 2700 L capacity
- 1080 Kg nominal load
- 1200 mm Opening Height

**3200 IGLOO**



- Double hook / Kinshofer
- 3200 L capacity
- 1280 Kg nominal load
- 1314 mm Opening Height

**CITE IGLOO**



- Double hook / Kinshofer
- 2200 L capacity
- 880 Kg nominal load
- 1200 - 1463 mm Opening Height

**METALLIC IGLOO**



- Double hook / Kinshofer
- 3200 L capacity
- 750 Kg nominal load
- 1300 mm Opening Height

CLICK ON CERTAIN ITEMS  
TO LEARN MORE.



# 360IGLOO

CRANE-LIFT RANGE ▶



## ACCESSORIES ▶

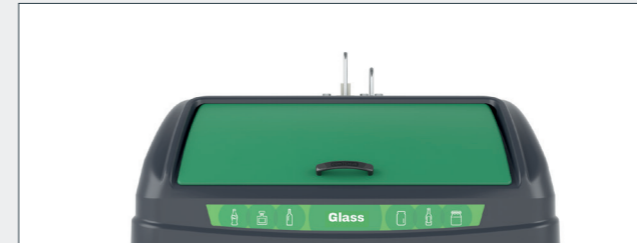

### NON-SELECTIVE WASTE OPENING -

Lightweight and shock-absorbing, slows down the closing of the lid to prevent harsh closures



### WASTE IDENTIFICATION -

Relief sign and Braille marking for visually impaired users. Placed on the container body to indicate the type of waste

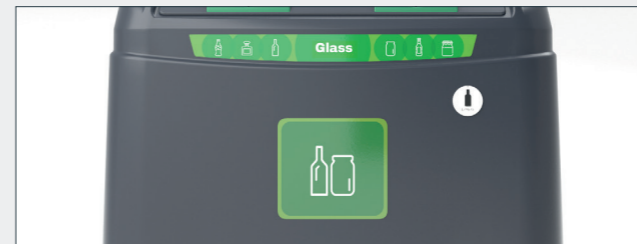

### CUSTOMISATION WITH STICKERS OR ADHESIVE VINYL -

Large customisation area on the body for logos and waste recycling instructions as well as on the front and rear edge



### MANUAL LOCK -

Manual key lock to control user access to the container



### LARGE PRODUCERS SYSTEM -

Lifting system that allows waste to be dumped into large containers



### CUSTOMISATION BY HOT STAMPING -

Large customisation area on the body for hot stamping, maximum size 400x400 mm



### PEDAL -

An integrated pedal conceived to ensure accessibility and ergonomics



## ACCESSORIES ▶



### SELECTIVE OPENINGS -

Openings used to recycle different types of waste: paper and cardboard, glass, packaging, organic and other waste...

Circular openings, available diameters:

- ▶ Ø200 mm
- ▶ Ø400 mm

Paper opening, available dimensions: 975 x 200 mm



### AGAINST THE WALL OPTION -

It makes it easier for the user to deposit waste when the container is located in areas that are difficult to access and cannot be reached from the pavement side. Loading and unloading is carried out in the same place

CLICK ON CERTAIN ITEMS  
TO LEARN MORE.



# OVAL IGLOO

CRANE-LIFT RANGE ▶



## ACCESSORIES ▶



### USER LID -

Light and buffered, slowing down the lowering of the lid to avoid a sudden closure. Available for different fractions

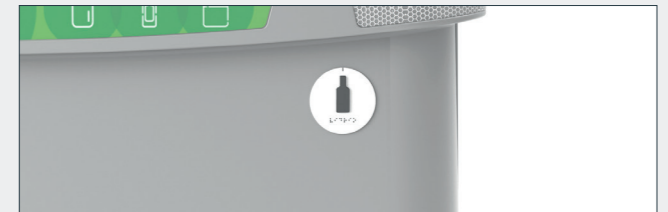

### WASTE IDENTIFICATION -

Relief sign and Braille marking for visually impaired users. Placed on the container body to indicate the type of waste



### CUSTOMISED STICKER OR ADHESIVE VINYL -

Large customisation potential in the body for logos and waste recycling instructions, to include the front and back edge



### COVERED SELECTIVE OPENINGS -

Accessory designed to prevent water seeping into the container. It guarantees uniformity in island design

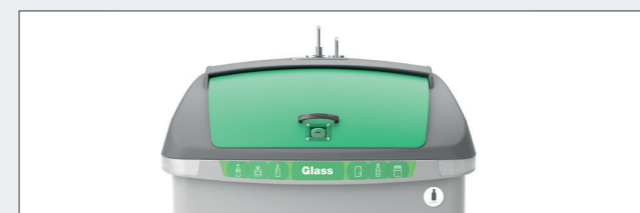

### MANUAL LOCK-

Preventing the container from opening



### ELECTRONIC LOCK -

Reliable and fitted lock to reduce incidents



## ACCESSORIES ▶



### SELECTIVE OPENINGS –

Used to recycle different types of waste: glass, paper and cardboard, packaging, MSW...

Circular openings, diameters available:

- ▶ Ø200 mm
- ▶ Ø400 mm

Paper opening, size available: 890 x 210 mm

Large lid-in-lid, useful size: 400 x 400 mm



### DOUBLE LID IN LID –

User lid made up of two big sized lid in lids. Specially designed for recyclable and non-recyclable waste. Dimensions of each lid in lid: 400 x 400 mm



### LARGE-PRODUCER SYSTEM –

System to help the emptying of large-producer containers, facilitating the deposit of waste

CLICK ON CERTAIN ITEMS  
TO LEARN MORE.



# OPTIK IGLOO

CRANE-LIFT RANGE ▶



## ACCESSORIES ▶



### VOLUME –

Designed to recycle glass, packaging, paper, organic matter and organic waste

Three volume options: 2m<sup>3</sup>, 3m<sup>3</sup>, 4m<sup>3</sup>



### SELECTIVE OPENINGS –

Possibility of user openings on all four sides: two on the front and back, and one on each side.

Circular openings (packaging and glass): Ø180 mm

Rectangular opening (packaging and paper): 350 x 150 mm

Large lid-in-lid (waste and organic matter): useful size, 330 x 400 mm

Rectangular opening (paper). Available dimensions:

- ▶ 2m<sup>3</sup>: 600 x 150 mm
- ▶ 4m<sup>3</sup>: 1000 x 150 mm; 1000 x 200 mm; 1000 x 350mm



### VOLUMETRIC BOX –

Accessory that limits the volume of waste introduced at each use



### PEDAL –

*\* Only available for regular hook lifting systems*

Emptying door fitted with a pedal to activate the downloading door, allowing the container to be fully emptied

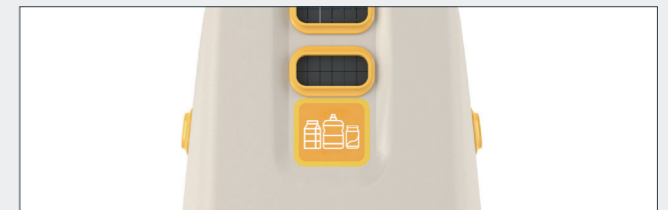

### CUSTOMISED STICKER OR ADHESIVE VINYL –

Large areas for customisation, using logos and waste instructions.

- ▶ Front and back, sizes available:
  - 420 x 320 mm
  - 420 x 630 mm
- ▶ Side: max. size 500 x 600 mm



### ACCESSIBLE OPENINGS –

User openings at different heights for greater accessibility.

- ▶ Front and back: 1200 mm and 1500 mm
- ▶ Side: 900 mm

CLICK ON CERTAIN ITEMS  
TO LEARN MORE.



# 2SIDE SYSTEM® IGLOO

CRANE-LIFT RANGE ▶



## ACCESSORIES ▶



### VOLUME –

Three volume options available:

- ▶ 2000 L
- ▶ 2800 L
- ▶ 3600 L



### SELECTIVE OPENINGS –

Openings used to recycle different types of waste: paper and cardboard, glass, packaging, organic and other waste...

- ▶ Circular openings Ø200 and Ø350 mm
- ▶ Rectangular opening 900 x 200 mm



### USER LID –

Equipped with a pedal to allow contactless opening of the lid. Sizes available:

- ▶ 400 x 400 mm
- ▶ 650 x 400 mm

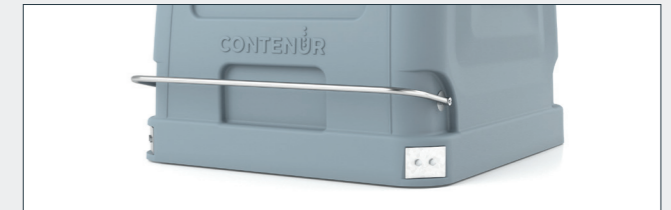

### PEDAL –

**CONTENUR**-patented hood design preventing the pedal from protruding over the sides



### MANUAL LOCK –

This allows the user lid to be opened with a key-operated manual lock



### CUSTOMISATION –

Each igloo may be customised with a sticker, facilitating citizen recycling by including pictures and icons to rapidly identify each container

Sizes available:

- ▶ 445 x 480 mm
- ▶ 795 x 480 mm
- ▶ 1145 x 480mm

CLICK ON CERTAIN ITEMS  
TO LEARN MORE.



# CIRCULAR IGLOO

CRANE-LIFT RANGE ▶



## ACCESSORIES ▶



### SELECTIVE OPENINGS –

Circular openings for packaging and glass fractions, diameters available:

- ▶ Ø200 mm
- ▶ Ø250 mm

Rectangular opening, sizes available:

- ▶ 410 x 150 mm
- ▶ 435 x 260 mm



### LARGE-PRODUCER SYSTEM –

A system used to help empty large-producer containers, facilitating waste deposit

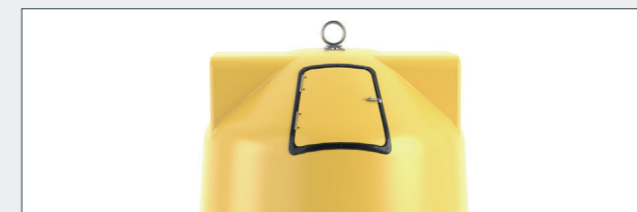

### PROFESSIONAL DOOR –

An accessory exclusive designed for the services sector, facilitating waste deposit



### CUSTOMISED STICKER OR ADHESIVE VINYL –

Each igloo may be customised with a sticker or adhesive vinyl



### REFLECTIVE STRIPS –

Highly visible and adhesive

CLICK ON CERTAIN ITEMS  
TO LEARN MORE.



# RECTANGULAR IGLOO

CRANE-LIFT RANGE ▶



## ACCESSORIES ▶



### SELECTIVE OPENINGS –

Circular openings for packaging and glass fractions, sizes available:

- ▶ Ø200 mm
- ▶ Ø250 mm

Rectangular openings, sizes available:

- ▶ 410 x 150 mm
- ▶ 780 x 150 mm
- ▶ 925 x 150 mm



### LARGE-PRODUCER SYSTEM –

A system to help the emptying of large-producer containers, to facilitate waste deposit



### PROFESSIONAL DOOR –

An accessory exclusively designed for the services sector, to facilitate waste deposit.

Size available: 455 x 270 mm

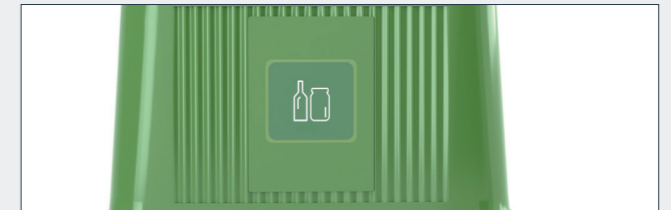

### CUSTOMISED STICKER OR ADHESIVE VINYL –

Each igloo may be customised with a sticker or adhesive vinyl



### REFLECTIVE STRIPS –

Highly visible and adhesive



### ACCESSIBILITY PACK –

- ▶ Accessible opening in the body
- ▶ Accessibility sign
- ▶ Braille plate

CLICK ON CERTAIN ITEMS  
TO LEARN MORE.



# AGORA IGLOO

CRANE-LIFT RANGE ▶



## ACCESSORIES ▶



### SELECTIVE OPENINGS –

Circular openings for packaging and glass fractions, available diameters:

- ▶ Ø200 mm
- ▶ Ø300 mm

Rectangular opening for the paper fraction, size available: 700 x 150 mm



### LARGE-PRODUCER SYSTEM –

A system to help the emptying of large-producer containers, to facilitate waste deposit

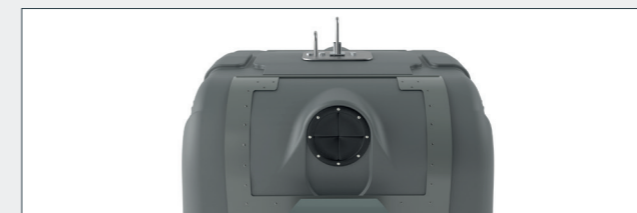

### PROFESSIONAL DOOR –

An accessory exclusively designed for the services sector, to facilitate waste deposit



### CUSTOMISED STICKER OR ADHESIVE VINYL –

Each igloo may be customised with a sticker or adhesive vinyl, maximum size 320 x 760 mm



### ACCESS FOR KIDS –

An accessory allowing kids to access the container, encouraging their participation in waste recycling

CLICK ON CERTAIN ITEMS  
TO LEARN MORE.



# 3200L IGLOO

CRANE-LIFT RANGE ▶



## ACCESSORIES ▶



### SELECTIVE OPENINGS –

Circular openings, for packaging and glass fractions, sizes available:

- ▶ Ø200 mm
- ▶ Ø250 mm
- ▶ Ø300 mm (front area)

Rectangular opening for the paper fraction, size available: 780 x 150 mm

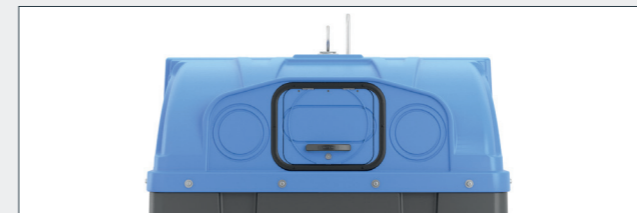

### PROFESSIONAL DOOR –

An accessory exclusively designed for the services sector, to facilitate waste deposit



### CUSTOMISED STICKER OR ADHESIVE VINYL –

Each igloo may be customised with a sticker or adhesive vinyl

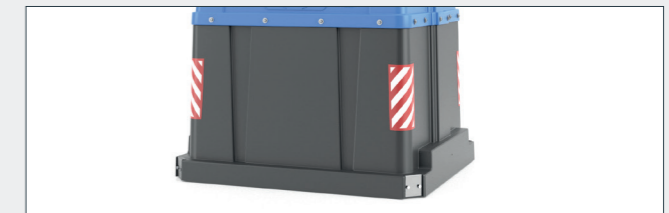

### REFLECTIVE STRIPS –

Highly visible and adhesive

CLICK ON CERTAIN ITEMS  
TO LEARN MORE.



# METALLIC IGLOO

CRANE-LIFT RANGE ▶



## ACCESSORIES ▶

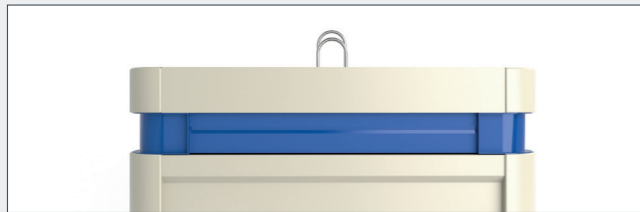

### SELECTIVE OPENINGS –

Circular openings for packaging and glass fractions, diameters available:

- ▶ Ø250 mm
- ▶ Ø300 mm

Rectangular opening for the paper fraction, size available: 1000 x 180 mm

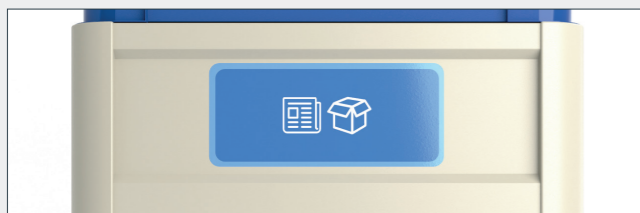

### CUSTOMISED STICKER OR ADHESIVE VINYL –

Each igloo may be customised with a sticker or adhesive vinyl



### CUSTOMISATION –

Customisation potential in container bodies, by printing the front and back.

Front area, maximum sizes available:

- ▶ 1240 x 140 mm
- ▶ 1240 x 170 mm
- ▶ 1240 x 240 mm

Back area, maximum size: 850 x 240 mm

# CITE IGLOO

CRANE-LIFT RANGE ▶



## ACCESSORIES ▶



### SELECTIVE OPENINGS –

Circular openings exclusively designed for recycling of the glass fraction, available diameter:

- ▶ Ø150 mm



### EMPTYING DOORS –

Anti-rust metal emptying system



### ACCESSIBLE OPENING –

Two openings located at a height of 1200 mm for greater accessibility



### CUSTOMISED WITH A STICKER OR ADHESIVE VINYL –

Each igloo may be customised with a sticker or adhesive vinyl



**www.  
contenur.  
com/en**

MK26CORP.CAT.ENEXP.V1