

Name	2815080	Seite/Page	1
Zeichnung/Drawing	3 D	Maßstab/Scale	
Profil/Profile	28X135	Datum/Date	08.12.2021
Zeichner/Drafter	SRM	File	2815080.dwg

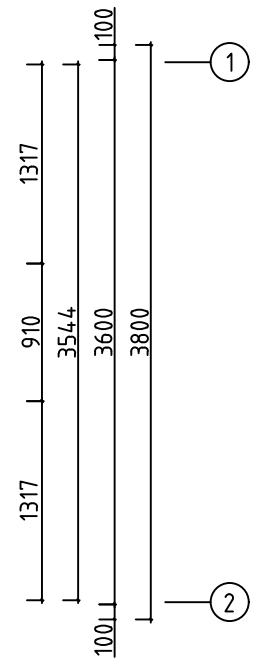

Model	2815080	Page/Seite/Page	2
Vue/Zeichnung/Drawing	PLAN DE MASSE-GRUNDPLAN - GROUNDPLAN	Echelle/Maßstab/Scale	1:50
Profil/Profile	28X135	Date/Datum/Date	08.12.2021
Rédacteur/Zeichner/Drafter	SRM	File	2815080.dwg

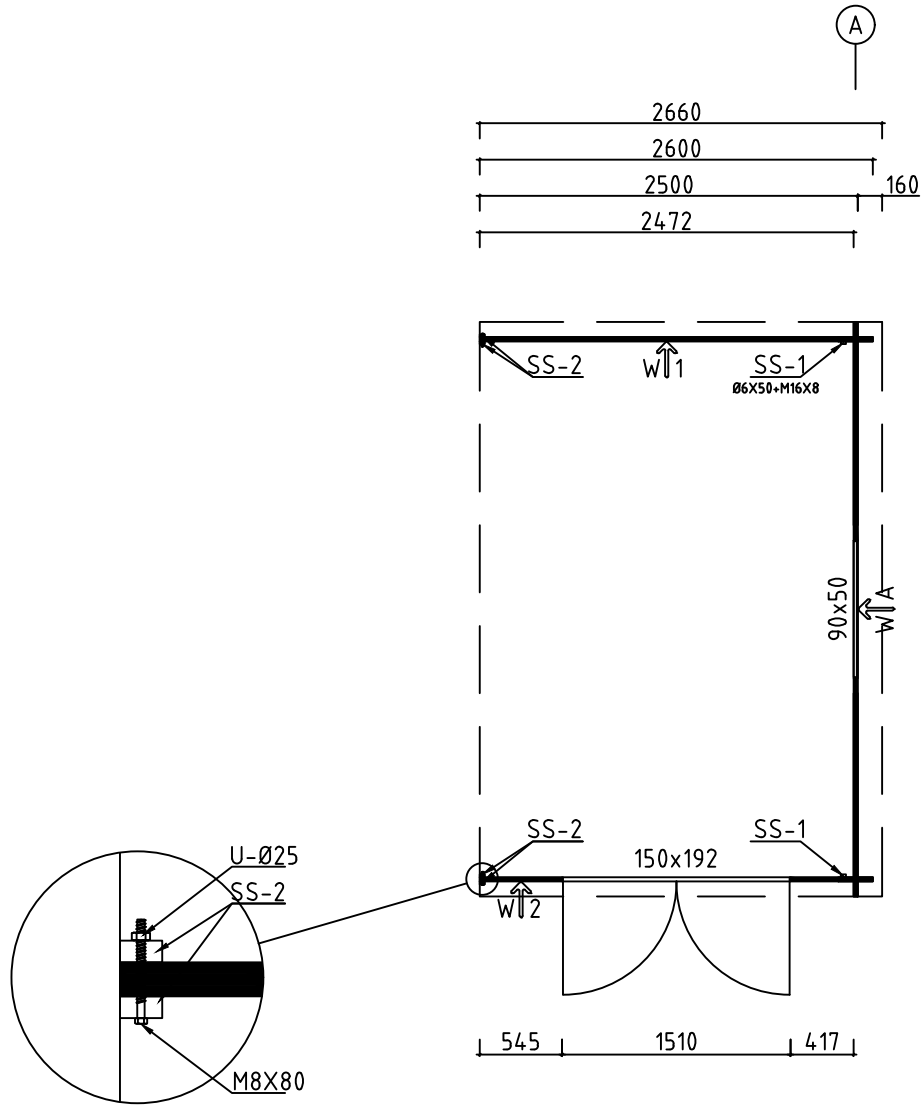
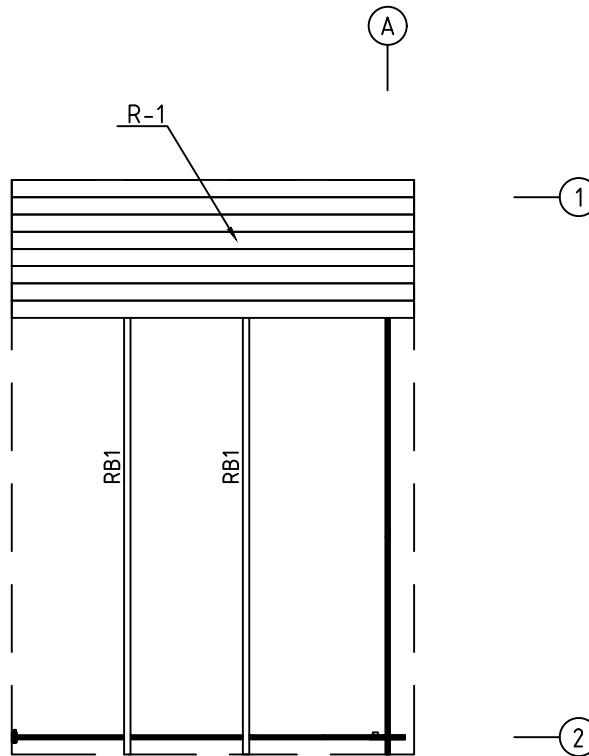

Model	2815080	Page/Seite/Page	3
Vue/Zeichnung/Drawing	VOLIGES-DACHBRETTER - ROOF BOARDS	Echelle/Maßstab/Scale	1:50
Profil/Profile	88X18 ou-oder- or 114X18 / 43X140	Date/Datum/Date	08.12.2021
Rédacteur/Zeichner/Drafter	SRM	File	2815080.dwg

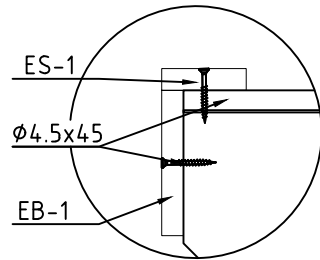

MUR-WAND - WALL A ↑

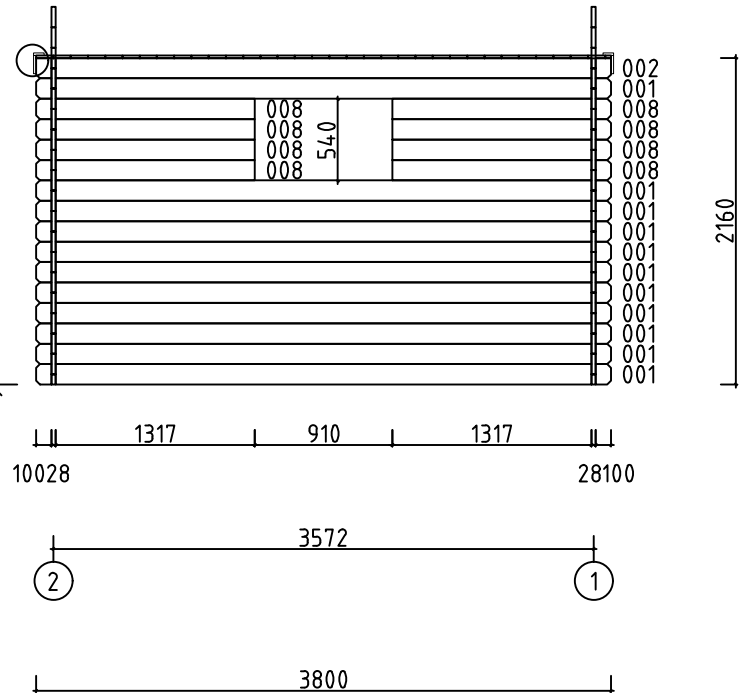

2160

Model	2815080	Page/Seite/Page	4
Vue/Zeichnung/Drawing	MUR-WAND-WALL A	Echelle/Maßstab/Scale	1:50
Profil/Profile	28X135	Date/Datum/Date	08.12.2021
Rédacteur/Zeichner/Drafter	SRM	File	2815080.dwg

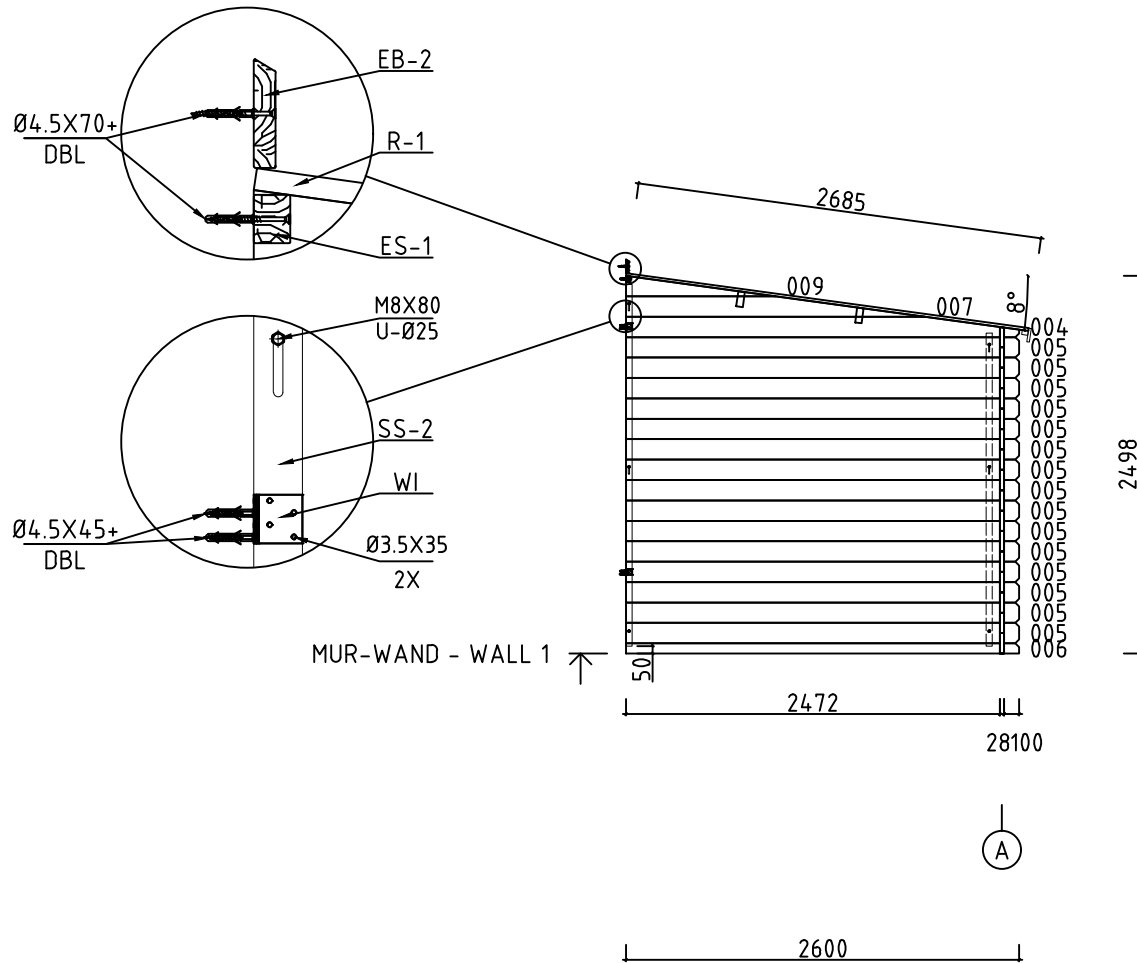



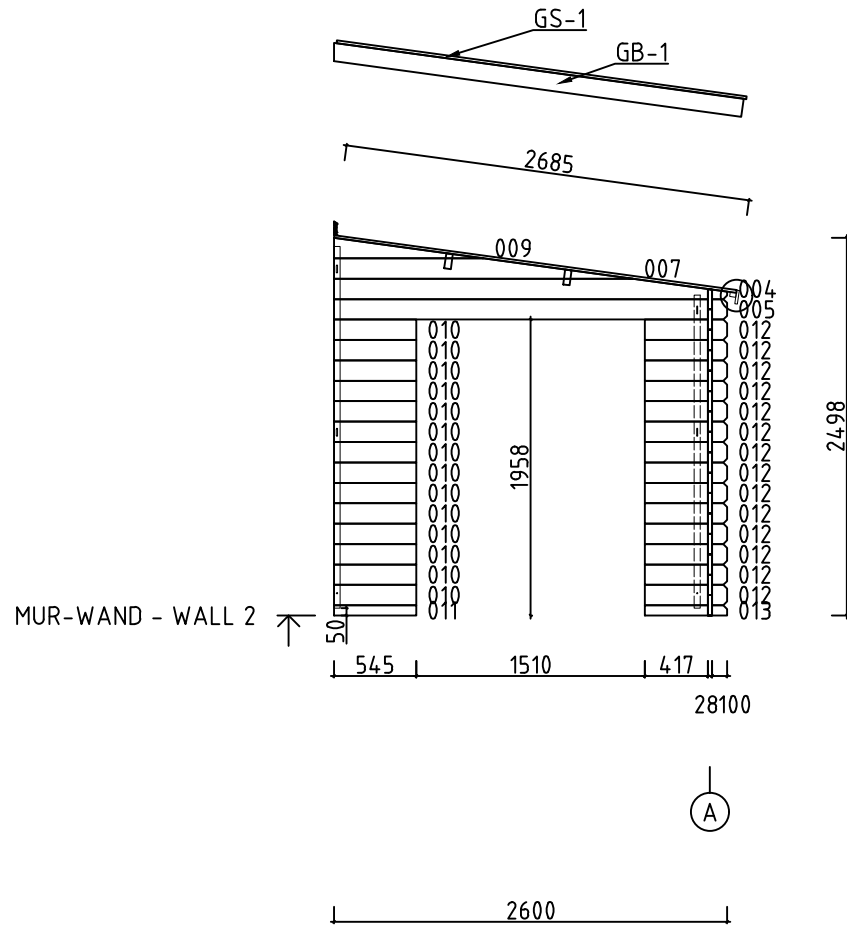











Model	2815080	Page/Seite/Page	5
Vue/Zeichnung/Drawing	MUR-WAND-WALL 1	Echelle/Maßstab/Scale	1:50
Profil/Profile	28X135	Date/Datum/Date	08.12.2021
Rédacteur/Zeichner/Drafter	SRM	File	2815080.dwg

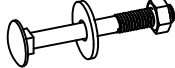

Model	2815080	Page/Seite/Page	6
Vue/Zeichnung/Drawing	MUR-WAND-WALL 2	Echelle/Maßstab/Scale	1:50
Profil/Profile	28X135	Date/Datum/Date	08.12.2021
Rédacteur/Zeichner/Drafter	SRM	File	2815080.dwg

Pos	Liste des pieces/Zeichnung/Drawing 2815080	Q.	P (mm)	L (mm)
001		11	28x135	3800
002		1	28x135	3800
003		1	28x135	3800
005		16	28x135	2600
006		1	28x68	2600
008		8	28x135	1445
010		14	28x135	545
011		1	28x68	545
012		14	28x135	545
013		1	28x68	545
W1-1		1	28x405	2600
W2-1		1	28x405	2600
RB1		2	43x140	3800
R-1	VOLIGES - DACHBRETTER - ROOF BOARDS 88mm ou-oder-or 114mm	44+1 34+1	88x18 114x18	2685
GB-1	PLANCHE DE RIVE - GIEBELLEISTE - GABLE MOULDING	2	18x120	2735
GS-1	BAGUETTE DE FIXATION DU FEUTRE BITUMEUX - DACHPAPPENLEISTE - ROOFING FELT FILLET	2	18x70	2735
EB-1	BANDEAU DE TOIT - TRAUFBRETTEN - EAVES BOARD	1	18x90	3800
EB-2	BAGUETTE DE FIXATION DU FEUTRE BITUMEUX - DACHPAPPENLEISTE - ROOFING FELT FILLET	1	18x90	3836
ES-1	CORNIERE DE RENFORT DE BORD DE TOIT - DACHRANDVERSTÄRKUNG - ROOF EDGE REINFORCEMENT	1	30x40	3800
ES-2	CORNIERE DE RENFORT DE BORD DE TOIT - TRAUFBRETTEN - EAVES STRIPS	1	30x40	3800
SS-1	LATTE ANTI-TEMPETE - STURMLEISTE - STORM PROTECTION	2	18x35	2070
SS-2	LATTE ANTI-TEMPETE - STURMLEISTE - STORM PROTECTION	4	18x35	2390
SH	CALLE DE FRAPPE - SCHLAGHOLZ - HAMMER BLOCK 28 MM	2		

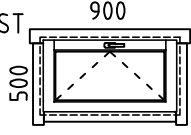
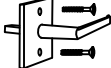
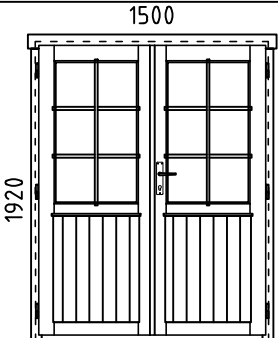
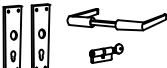
Pos	Liste des pieces/Zeichnung/Drawing 2815080	Q.	P (mm)	L (mm)
HS	VIS DE FIXATION DES CORNIERES - SCHRAUBEN FÜR WINKELHALTERUNGEN - SCREWS FOR ANGLE BRACKET (WI) 	8	Ø3.5X35	
HS	VIS DE FIXATION DES CORNIERES - SCHRAUBEN FÜR WINKELHALTERUNGEN - SCREWS FOR ANGLE BRACKET (WI) 	8	Ø4.5X45	
HS	VIS DE FIXATION POUR PLANCHE DE RIVE -SCHRAUBEN FÜR GIBELLEISTE - SCREWS FOR GABLE MOULDING (GB-1) 	12	Ø4.5X45	
HS	VIS DE FIXATION POUR BANDEAU DE TOIT - SCHRAUBEN FÜR TRAUFBRETTEN - SCREW FOR EAVES BOARDS (EB-1) 	8	Ø4.5X45	
HS	VIS POUR RENFORT DE BORD DE TOIT - SCHRAUBE FÜR DACHRANDVERSTÄRKUNG - SCREW FOR ROOF EDGE REINFORCEMENT (ES-2) 	8	Ø4.5X45	
HS	VIS POUR BAGUETTE FIXATION FEUTRE BITUMEUX - SCHRAUBEN FÜR GIBELDECKLEISTEN - SCREWS FOR GABLE COVER STRIPS (GS-1) 	12	Ø4.5X45	
HS	VIS POUR BAGUETTE FIXATION FEUTRE BITUMEUX - SCHRAUBEN FÜR DACHPAPPENLEISTE SCREW FOR ROOFING FELT FILLET (EB2) 	8	Ø4.5X70	
HS	VIS POUR RENFORT DE BORD DE TOIT - SCHRAUBEN FÜR DACHRANDVERSTÄRKUNG SCREW FOR ROOF EDGE REINFORCEMENT (ES-1) 	8	Ø4.5X70	
HS	VIS POUR PANNE DE TOIT - SCHRAUBEN FÜR DACHBALKEN - SCREWS FOR ROOF BEAM (RB) 	4	Ø6X160	
HS	VIS POUR LAME ANTI-TEMPETE - SCHRAUBEN FÜR STURMLEISTE - SCREWS FOR STORM PROTECTION (SS1) 	6	Ø6X50	
KL	RONDELLE POUR LAME ANTI-TEMPETE - DICHTSCHEIBE FÜR STURMLEISTE - WASHER FOR STORM PROTECTION (SS1) 	6	M16X8	
NF	POINTE POUR TOIT - NÄGEL FÜR DACHBRETTEN - NAILS FOR ROOF BOARDS (R) 	272	Ø2.5X60	
HS	BOULON M8 - BOLZEN M8 - BOLT M8 (SS2) 	4	M8X80 U-Ø25	
WI	CORNIEREEN MÉTAL - WINKELHALTERUNGEN - ANGLE BRACKET 	4	40x40	
DBL	CHEVILLE - DÜBEL - WALL PLUG 	24	Ø8X40	
	VENSTER - FENSTER - WINDOW, AST  900 500	1	900x500	
AMV	MONTAGE VAN DE VENSTERGRIEP - FENSTERGRIFF - WINDOW HANDLE FITTINGS 	1		
	PORTE - TÜR - DOOR, AST  1500 1920	1	1500X1920	DROITIER/DIN RECHTS/ /RIGHT HANDED
UMV	SET DE GARNITURES DE SERRURE DE PORTE - TÜRGRIFF - DOOR HANDLE FITTINGS (AST) 	1		