



H 5014 Serie Bernina

design Fusital Workshop



Material **Stainless Steel AISI 316 L**/Materiale Acciaio Inox AISI 316 L

Product Submittal

Custom finishes available
 Spring assist built in rosette
 Passage, privacy, dummy, multipoint, mortise hardware available
 Accommodates all standard and some custom backset dimensions
 A complete selection of other matching hardware may be available

Inox | Door levers/Maniglia





Finish			
32	RPS		RSS
32D	RPS		RSS

Finishes
 32= Polished Stainless Steel
 32D= Satin Stainless Steel

Functions
 PGE= passage
 PCY= privacy
 DMY= dummy
 ML-F= mortise lock
 MULTI-POINT TRIM

Trim Options
 RPS= standard style stainless steel rosette
 RSS= small stainless steel rosette
 NES= narrow long escutcheon plate stainless steel
 ERS= rectangular style long escutcheon plate stainless steel

Finish		
32D	NES	ERS

Sizes/Misure

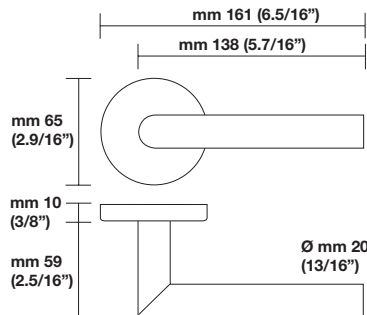

Trim options/Opzioni

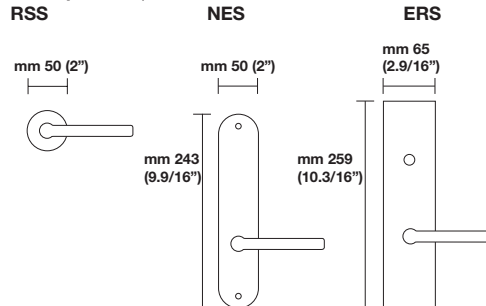

To order Valli&Valli products, informations should be specified in the same sequence as the example given:

1.Lever/Knob	2.Trim options	3.Function	4.Finish	5.Handing	6.Backset	7.Miscellaneous
H5001	RPS	ML F	32D	RH	2-1/2"	2-1/4" thick

RSS (2"-50mm rosette). RSS roses Privacy, supplied with 105 RSS Privacy Bolt. RPS/RQS/ERS (2.9/16"-65 mm) for standard 2.1/8" cross bore.
 NES Specify handing. Privacy uses a Privacy Bolt. **RSS = Trim not recommended for commercial use.**
 Conversions from metric to U.S. measurements are approximate.

Valli&Valli U.S.A. Inc.
 Architects and Designers Building
 964 Third Ave., Suite 563/Annex
 New York, NY 10155
 sales@vallivalli-us.com
 T 212 326 8811
 F 212 326 8816
 Toll Free 877 326 2565

820 S. Rockefeller Avenue,
 Suite E
 Ontario, CA 91761
 w.sales@vallivalli-us.com
 T 909 390 0333
 F 909 390 0353
 Toll Free 800 423 7161